

# Bullwinkle's™



## Maintenance & Operation Manual



AVG PRODUCTIONS.

**MAINTENANCE AND OPERATION MANUAL**

Prepared By

**AVG PRODUCTIONS, INC.**

For

**BULLWINKLE'S INCORPORATED**

© Copyright 1984 by AVG Productions, Inc.

## PREFACE

This Maintenance and Operation Manual (the "Manual") was prepared by AVG Productions, Inc. ("AVG") for the exclusive use of Bullwinkle's Incorporated and its franchisees (herein collectively called "BW"), in connection with the maintenance and operation of BW's animated Greeter and Theatre Shows (jointly called the "Show"). The Manual contains proprietary information of AVG and BW and the contents of the Manual are not to be disclosed to others without the prior written consent of AVG or BW.

The most important element of operating and maintaining the Show is to use qualified personnel. At least one person at each restaurant facility should be trained in the operation and maintenance functions. AVG will provide free training at its facility in California at BW's request.

The Manual has been designed to provide a qualified technician with comprehensive operation and maintenance procedures. However, questions or problems may arise which are not answered or covered by the Manual. If and when this occurs, please contact AVG by telephone instead of experimenting with corrections or procedures. The person to contact is:

*KEN DOYLE*

~~Richard Sweet~~

Customer Service Manager

AVG Productions, Inc.

25356 Rye Canyon Road

Valencia, CA 91355

(805) 257-2150

## WARRANTY

AVG warrants all supplied equipment, props and systems against defects in materials, design or workmanship for a period of six (6) months from the date of turn-key completion of Show installation, except in the case of manufacturer-warranted components for a longer period of time in which case the original component manufacturer's warranty shall prevail. AVG will supply replacement parts, including shipping costs, where simple part replacement within the abilities of BW's on-site service technician will correct a warranted defect. If correction of a defect within the warranty period requires more highly skilled technicians, AVG will supply those services, including all costs attendant to providing repairs at the BW's Show site, without cost to BW.

The repair and replacement remedy shall be BW's exclusive remedy under the foregoing warranty and BW shall not have any other claim for damages thereunder, including consequential damages such as lost profits or revenues. This section is intended only to limit AVG's liability for operating failures and is not intended to limit AVG's liability for direct and/or consequential damages arising from its failure otherwise to perform under this Agreement.

The foregoing warranty extends only to the Shows designed, manufactured, programmed and installed by AVG. If BW modifies a Show or reprograms or changes the programs, in any manner not authorized by AVG in its Maintenance and Operation Manual, AVG's warranty as to that portion of the Show modified or reprogrammed shall expire. AVG does not make any warranty with respect to computer programming performed by parties other than AVG.

AVG makes no other warranty, express or implied.

## TABLE OF CONTENTS

PREFACE

WARRANTY

CHAPTER 1. GENERAL INFORMATION

CHAPTER 2. FUNCTIONAL DESCRIPTION

I - Central Control System	2-1
II - Primary Pneumatic System	2-4
III - Secondary Pneumatic System	2-7
IV - Sound System	2-9
V - Lighting system	2-11
VI - Snidely Whiplash Control System	2-14

CHAPTER 3. OPERATION & MAINTENANCE

I - Routine Maintenance & Start-Up	3-1
II - Periodic Maintenance	3-3
III - Emergency Procedures	3-18
IV - Plastics Maintenance	3-19
V - Cosmetics Maintenance	3-20
VI - Costume Maintenance	3-27

CHAPTER 4. TROUBLE SHOOTING

I - General Trouble Shooting Procedures	4-1
II - Digital Function Trouble Shooting Guide	4-6
III - Analog Function Trouble Shooting Guide	4-10
IV - Servo Card Replacement & Calibration	4-16
V - Servo Valve Trouble Shooting	4-18
VI - Repair & Replacement of Standard Eye Assy.	4-19
VII - Replacing Functional Parts	4-37

CHAPTER 5. PARTS LISTS

I - Animation Parts List	5-1
II - Electronics Parts List	5-4
III - Figure Parts List	5-7
IV - Pneumatic Parts List	5-16

CHAPTER 6. FUNCTION DATA

I - Figure Data Lists	6-1
II - Figure Functions & Bit Maps	6-15
III - I/O Cable Guides & Elco Connector Pin Pairs	6-38

CHAPTER 7. SCHEMATICS

CHAPTER 8. TECHNICAL GLOSSARY

CHAPTER 9. MISCELLANEOUS INFORMATION

INDEX

## CHAPTER 1

### GENERAL INFORMATION

The Bullwinkle's Animated Show is based on the popular cartoon characters of Bullwinkle, Rocky, Dudley Do-Right, Hoppity Hooper, Tooter Turtle, Underdog, Boris and Natasha Badenov, and Snidely Whiplash. Snidely Whiplash greets your guest from his jail cell as they arrive. The Theatre Show includes eight characters who are assembled together on a stage to sing and play for your audiences. In between stage show programs, there is a water show comprised of fountains of water that "dance" to music.

The figure animation is powered by pneumatic actuators and controlled by a central computer. The show program tape contains all the data for the sound track, lighting control, figure animation, and water show control. There are over 32 show programs available and many more are being produced. AVG Productions, Inc. will also develop custom show programs to meet any needs at Bullwinkle's, Inc. request only.

The following illustrations and manual will help to clarify the functions and controls of the show.

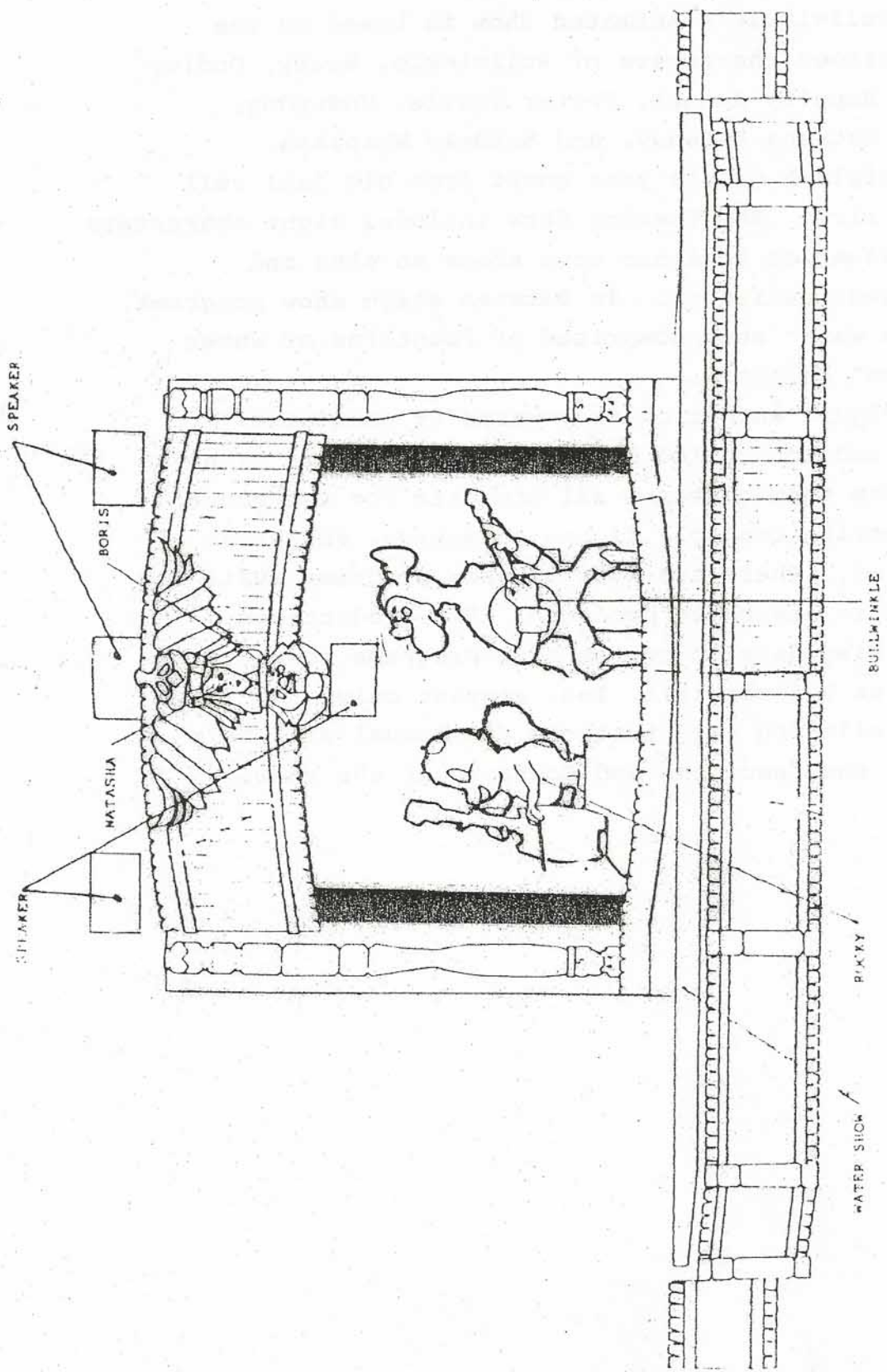

STAGE LAYOUT

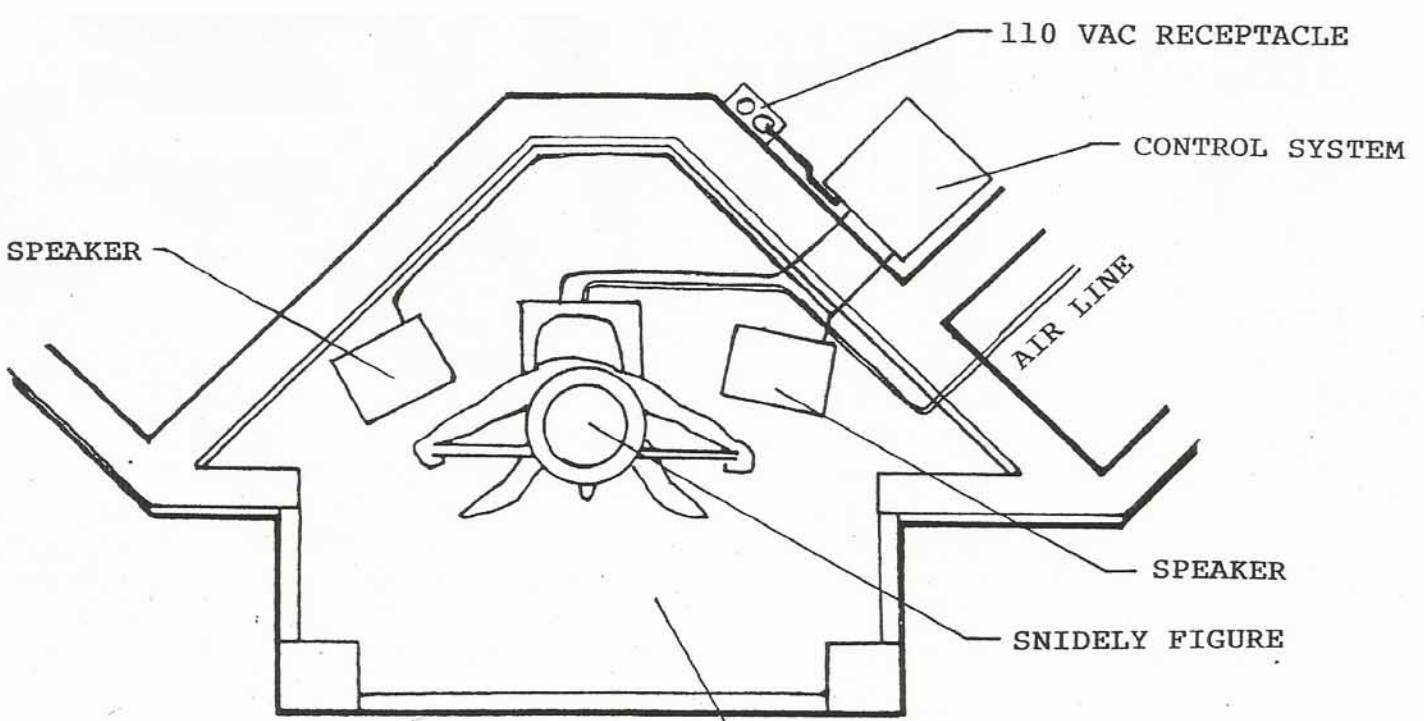

LIGHTS ARE  
 HOUSE LIGHTS - BUT  
 SHOW CONTROLLED

SNIDELY STAGE AREA

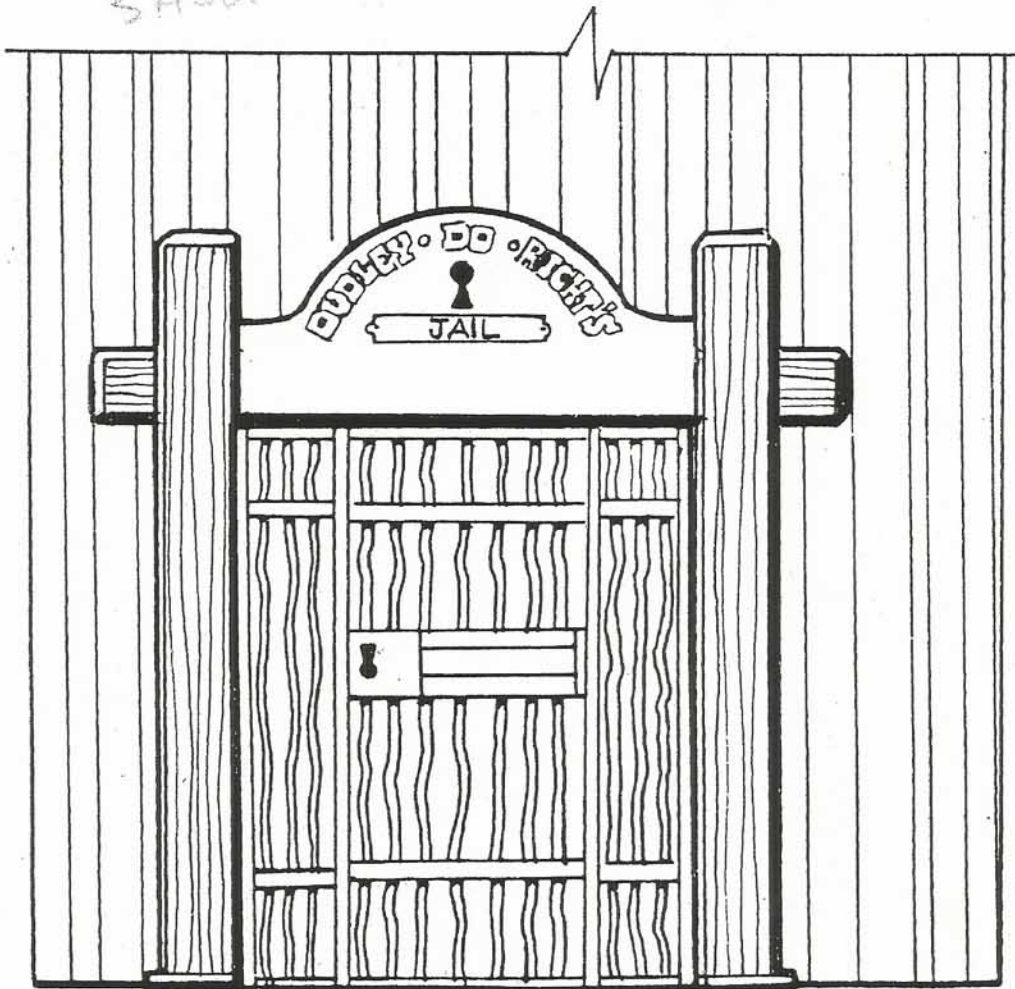

SNIDELY STAGE



## CHAPTER 2

### FUNCTIONAL DESCRIPTION

#### I - Central Control System

The AVG theatronic entertainment system is a coordinated fusion of lights, sound and robotic movement controlled by a central computer system.

The central processor unit (CPU) is the heart of the computer system. It is responsible for the retrieval of the data used to control specific shows. This section consists of a CPU Board, Control Module and chassis.

Within this CPU system lies the necessary logic to maintain the show data and output in a predefined manner. The show data is output at a preselected rate of 15 frames per second. The CPU has a real time clock that is used to provide this time base. As the show data is output, the CPU keeps track of the proper address that the data is to be sent to. This information is then sent to a parallel I/O port provided on the CPU Board. This port is used to interface with the I/O system via a 50 conductor flat cable.

The I/O system consists of nine 19" X 3.5" rack mounted chassis. Each chassis contains an I/O circuit board and a three output (+5, +12, +24 VDC) power supply.

The I/O system is used to convert the CPU data to real world signals that can run the show functions. The I/O system is comprised of two types of interface panels, each supplying 16 separate interface signals. The digital I/O panel provides digital (on or off) commands of 24 VDC at 1 amp. Each individual output is fused on the front of the I/O panel with a 1 amp micro fuse. Adjacent to each fuse is a three-position toggle switch. This switch allows the individual output to be manually activated (on), set for automatic computer control (auto), or completely disabled (off).

The second type of I/O is an analog I/O panel. This has 16 individual analog (0-10 VDC) output commands. Again, each output is individually fused. However they cannot be manually controlled from the I/O panel itself. The fact that each I/O panel provides its own power for that panel's functions allows for very modular construction. On the back of each I/O panel are two 38 pin Elco Connectors. Each one of these connectors provides eight signals. Thus, each panel provides 16 outputs. From these Elco connectors, cables are used to connect them to their appropriate point of termination on the cross-connect panel. From the cross-connect panel command signals are distributed to the various show elements through a series of multi-conductor cables.

The pneumatic actuators that power the robotic figures are controlled by a combination of digital and analog output commands.

The computer controlled audio functions are all digital commands.

The lighting system is also controlled by both analog and specially modified ramped digital commands. These modified commands ramp from 0-10 VDC with a specific adjusted rise time.

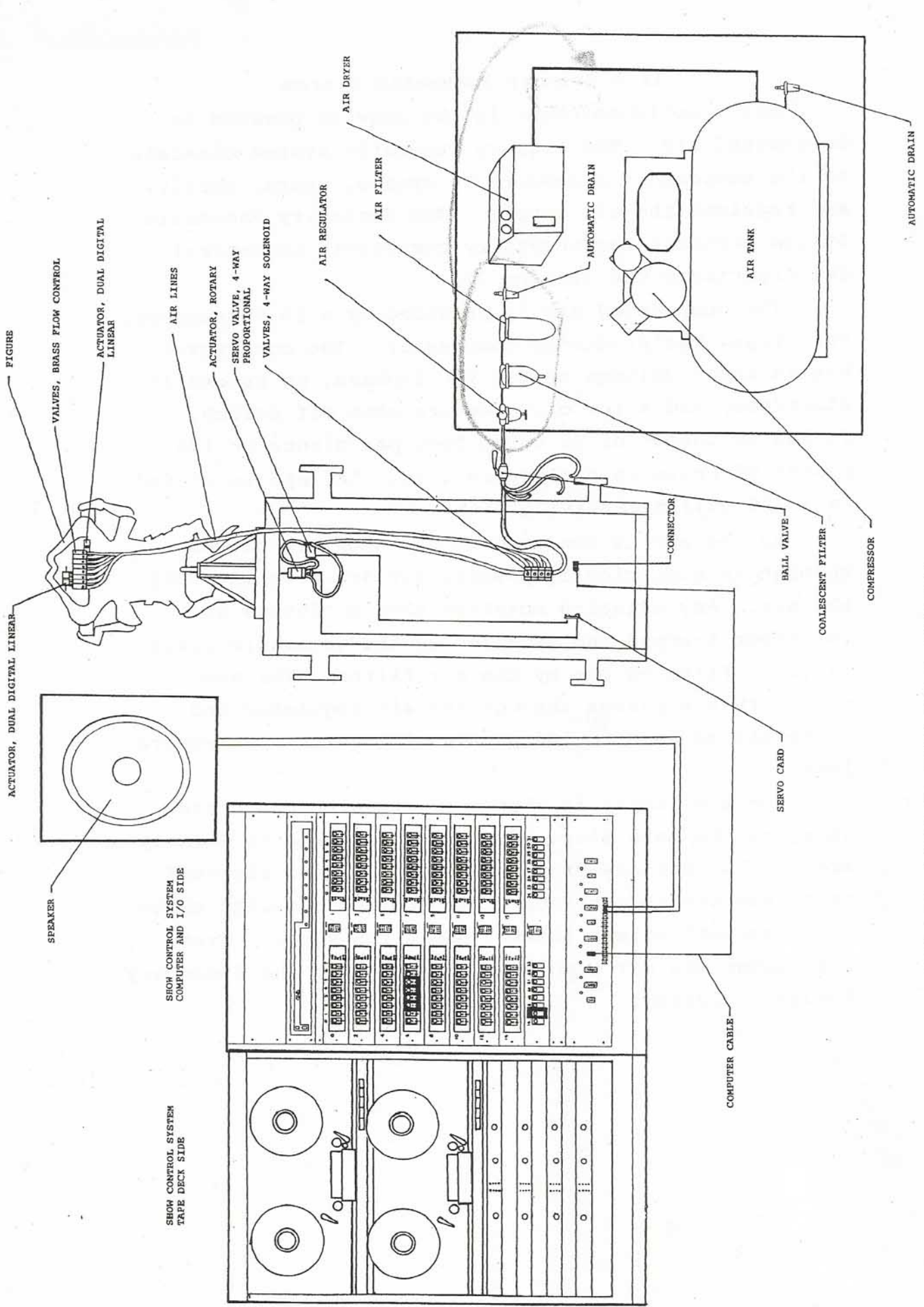

GENERAL FIGURE ANIMATION SYSTEM

## II - Primary Pneumatic System

All robotic movement in the show is powered by compressed air. The Primary Pneumatic system consists of the components necessary to create, store, purify, and regulate the air supply. The Secondary Pneumatic System contains the necessary components to control and distribute the air supply.

The compressed air is produced by a 10 horsepower, two-stage, reciprocating compressor. The compressor has an input voltage of 208 VAC 3-phase, an automatic start/stop and a low oil pressure shut off switch. It has an output of 45 cubic feet per minute at 120 pounds of pressure per square inch. The air is stored in a 120 gallon receiving tank.

As the air is consumed by the show, it passes through an electrically powered air dryer which cools the air. Any existing moisture then condenses and is either trapped and expelled by the automatic drain valve or filtered out by the air filter. The now cool, dry air passes through the air regulator and is regulated down to 100 pounds of pressure per square inch.

The air supply is then teed-off with one branch going to the main stage and the other going to Snidely's stage. The Snidely branch ends with a ball shut-off valve and the show branch is manifolded off with three ball shut-off valves located under the stage. From this point the air supply intersects with the Secondary Pneumatic System.

SYSTEM STATUS MONITOR

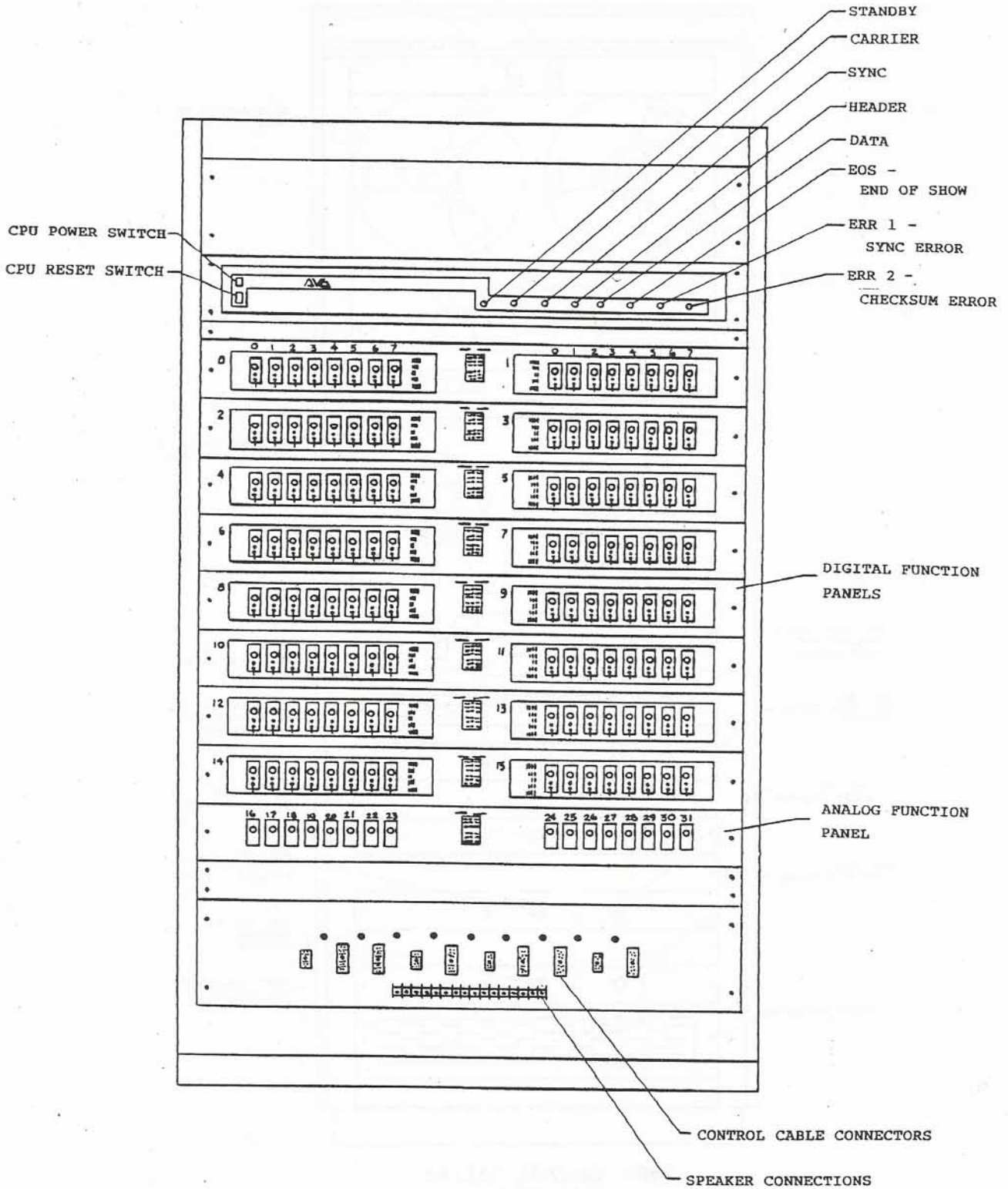

SHOW CONTROL SYSTEM  
COMPUTER SIDE

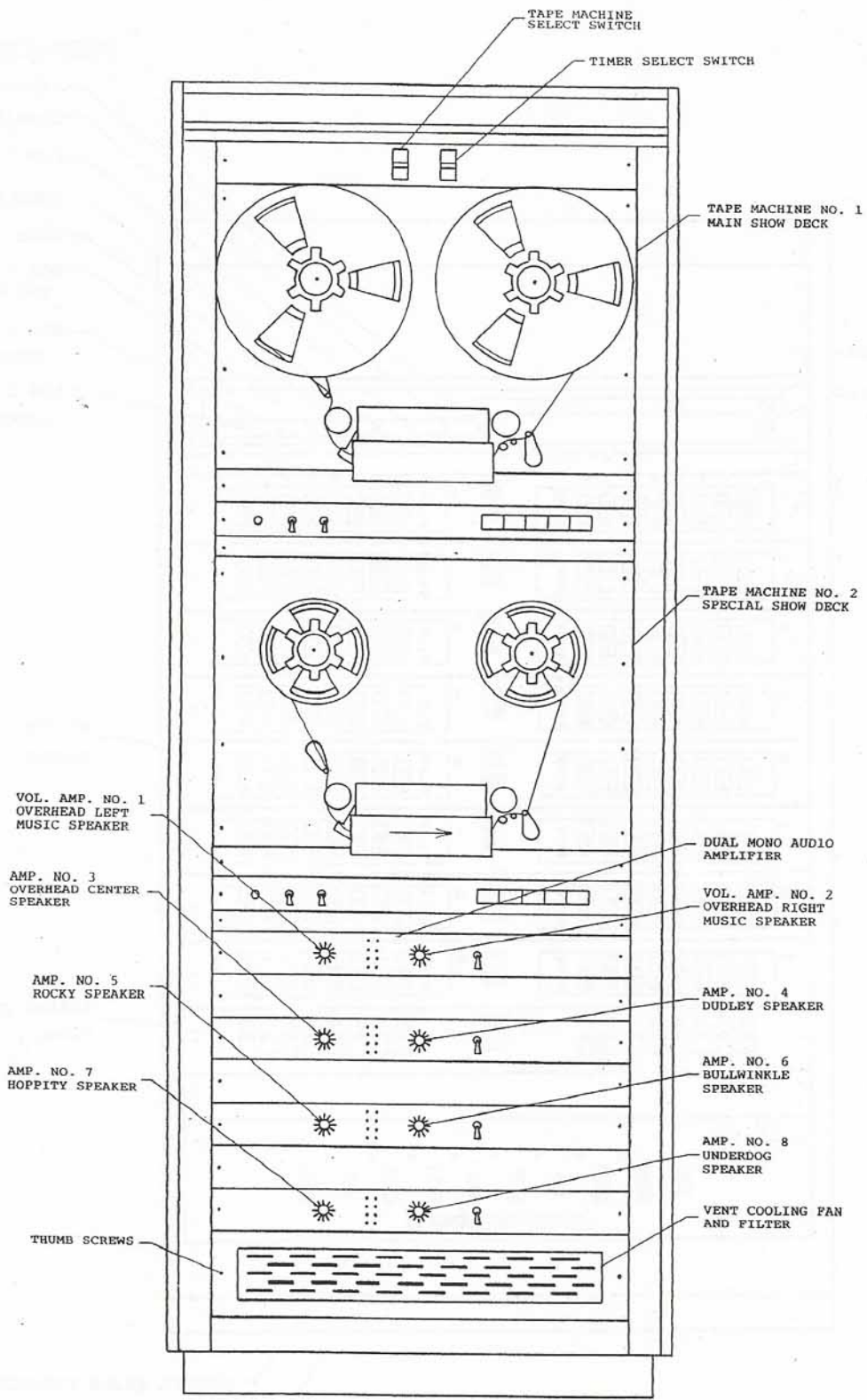

SHOW CONTROL SYSTEM  
TAPE SIDE

### III Secondary Pneumatic System

Like the I/O system, the robotic movements are also implemented in two distinct ways. Almost all of the robotic functions are of the digital type. A digital movement is a simple two-position motion. Even though the motion is limited to two positions, the speed with which the movement attains those positions is completely adjustable. When these speed adjusted movements are integrated with other associated movements the result is very effective and life-like.

There are four main components used to initiate any digital movement:

(1) The digital valve is essentially an electrically operated (24 VDC) air switch. It allows a regulated flow of air to pass from one of two ports depending on whether the solenoid is energized or not. In other words, when the valve receives a digital command, air is allowed to pass through one port. When the command is removed it allows the air to pass through the other port.

(2) The second component is the pneumatic actuator. Actuators are simple mechanical devices with two main components; the cylinder and the piston or vane (the latter being used in rotary actuators). The cylinder is the non-moving housing of the actuator. The piston or vane is the movable part of the device. The piston moves inside of the cylinder as a function of applied air pressure. Ports in the cylinder body allow air pressure to be applied to one side of the piston (or vane) or the other. The result is controllable mechanical movement.

(3 and 4) The final components in the system are the flow controls and the air lines. The flow controls are placed in line with the air lines that run between the valve and the actuator. Their purpose is to restrict the flow of air as it is leaving the depressurized side of the actuator piston. This controls the speed that the piston is allowed to move from

one extreme to the other. The end result is the ability to control speed of a digital robotic movement independently in each of its directions.

The second category of robotic movement is the analog type. This type of actuation is used where precise positioning is required. It allows completely controllable motion in terms of both speed and position. An analog function is capable of any position between the two mechanical extremes.

There are four main components used to initiate analog robotic movements:

(1) For each analog function there is a servo card electronic module located in the figure. The Card serves as an interface between the Analog I/O System of the computer and the individual servo valves. The module conditions the signal from the computer and detects the position of an individual function through an electrical feedback system. By comparing the command signal and the feedback signal the module compensates for varying load conditions to attain the desired position. Each servo card is set up for the individual function that it controls.

(2) The servo valve is an electronically operated pneumatic control device. Like the digital valve it has two air ports which go to opposing sides of a pneumatic actuator. However, the servo valve can proportionately balance the flow of air on the opposing sides of the actuator piston or vane. This allows the piston to assume and hold any desired position within its mechanical extremes.

(3) The feedback pot is simply a variable resistor that is attached directly to the pneumatic actuator. By varying the resistance in direct proportion to the movement of the actuator, the servo card knows where the analog function is physically, relative to its full mechanical travel potential.

(4) The last part of the system is the actuator itself. Other than having a feedback pot attached to it, it is exactly like a digital actuator.



#### IV - Sound System

The audio system has four main sub-systems:

(1) The AVG system uses two OTARI reel to reel tape decks to play back the audio portion of the show and the retained data for the individual shows. The tape deck is a four-track  $\frac{1}{4}$ " play-back only device. The tape speed is 7.5 IPS. Tracks 1-3 contain the recorded show material and track 4 contains the data for the show. As the tape plays the data it is demodulated by the control module, fed to the CPU, and then put out to the I/O system.

The top tape deck in the system plays the main shows for the restaurant. It is automatically started by the control module at preselected intervals of 3 or 5 minutes between shows.

The lower deck is used for specialty shows (birthdays, etc.). This machine must be started manually, typically from the remote start station. Through a series of relays and associated circuitry, the lower deck is allowed to access the computer and the rest of the audio system. At the end of the specialty show, control is automatically given back to the main tape deck.

(2) Optical sound switching is done in the control module. A series of optical resistors are used to move sound that exists on a particular tape track to any or all of several speaker locations. Tape track 3 is dedicated to speakers 1 and 2 only. Tape tracks 1 and 2 may be directed to any of the other speakers in the show. This system is used to simulate multiple outputs from three audio dedicated tracks. The manner in which this system is used is dictated in the initial show programming. The system is automatic and under computer control.

(3) The show uses four dual-monaural professional audio amplifiers. This provides eight separate sources of amplification. Each amplifier has an individual gain control on the front panel. Each gain control

SOFTWARE  
(CONTROLLED)

should be set to an appropriate level for the acoustic environment. For further specific information about the amplifiers refer to the enclosed factory manual.

(4) Just as there are eight amplifiers in the show system, there are eight speakers driven by them. The amplifiers and speakers exist in dedicated pairs. That is, amplifier number 1 powers speaker number 1, and so on, through number 8. The exact locations of the speakers are shown on the illustrations provided. The locations were chosen to give maximum character directionality and minimum visual disruption to the show. The crossover levels on the speakers have been set by AVG at the time of installation. These are the recommended levels. For further specific information about the speakers refer to the enclosed factory manual.

## V - Lighting System

The lighting system consists of three main sub-systems:

(1) The dimmer interface module is a small plastic enclosure mounted on the main power board. The computer control cable attaches to the module and two flat cables send the appropriate signals to the dimmers. The module is essentially a series of op-amps that receive either conventional analog command or simulated analog (ramped digital) commands from the I/O system. It then outputs conditioned signals to the dimmers. The house-light selector switch on the module allows the user to choose between automatic computer control of the house-lights or manual over-ride of the automatic control.

(2) The light system uses two Litelab model 835 load drivers. These are conventional triac controlled light dimming devices. Each dimmer has eight independent output channels. Each channel has a nominal maximum rating of 1000 watts. Of the sixteen available channels, ten are used for the animated show, three are used for the water show and the remaining three control the house lights. The enclosed listings of show function locations and lighting plot diagrams will indicate which dimmer channel controls which specific lighting functions.

(3) The show contains various theatrical light instruments to provide the different lighting effects needed for the show. All lights are directly controlled by the dimmers with the exception of the strobe light which is controlled by a digital command through a KUP type relay located in dimmer number two.

All animated figures with the exception of Hoppity Hopper and Tooter Turtle, are individually illuminated by two ellipsoidal spotlights (a total of ten instruments). The three curtain wash lights are 6 inch fresnels. Hoppity and Tooter are lit with one 3 inch fresnel

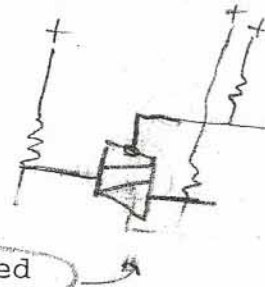

each. Four multi-R40 floods are used for background illumination. For information on the water show lighting refer to the water show manual. All of the light instruments used in the show are industry standard and replacement bulbs should be available through a local lighting distributor.

## VI - SNIDELY WHIPLASH CONTROL SYSTEM

Snidely is controlled by a completely separate animation system from the main show. The Snidely system is capable of controlling eight digital functions with full audio reproduction. There are four main components in the system:

(1) **SINGLE CHANNEL PLAYBACK MODULE** - This is an AVG designed electronic module capable of processing and outputting eight separate digital (24 VDC) commands. The unit has on-board demodulation and I/O. Each command function is individually fused. Each function can be manually engaged, set for automatic operation, or disabled with the on-board three-position toggle switch. From the playback system chassis, a multi-conductor cable goes to the robotic figure. At the figure base the cable interfaces with the digital valves.

(2) **TASCAM 133 CASSETTE DECK** - This is a professional 3-track cassette deck that runs at 3.5 IPS. The audio portion of the tape is on track one and the data is on track three. Data is fed from the deck to the playback module and the audio is fed directly to the audio amplifier. A <sup>25 CYCLE</sup> cue tone is present at the end of the show tape. The deck receives the tone and automatically rewinds and restarts the show. Output level controls on the deck should be depressed. The CUE switch should be set to REW and the REWIND switch to BOT/PLAY. Refer to Snidely Control System illustration.

WHAT SETTING?

(3) **AUDIO AMPLIFIER** - The audio amplifier is implemented in a bridged-mono configuration. It receives low level signals from track one of the tape deck and sends them out to the speakers. Amplifier gain should be set to the desired audio level.

(4) **SPEAKERS** - The figure uses two eight inch two-way eight-ohm speakers run in parallel. The speakers are enclosed in props and set on the floor of the jail cell.

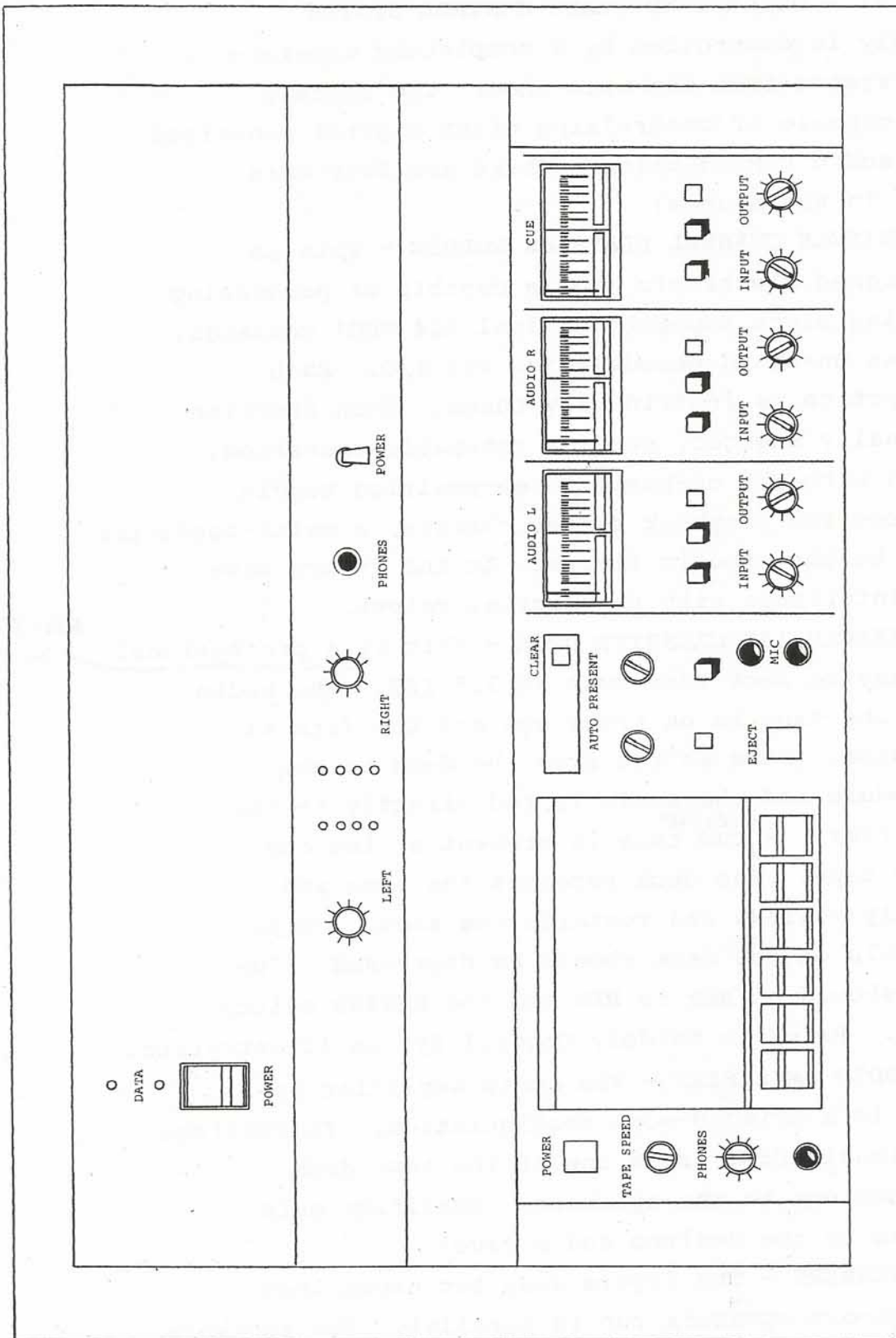

SNIDELY CONTROL SYSTEM

CHAPTER 3

OPERATION & MAINTENANCE

I - Routine Maintenance and Start-Up

- DATA, NEW 11/11/11, M. QUINTER*
- IF OILY THEN LEAVE PERMIT*
- ?*
- A. **OIL CHECK** - Check oil in the air compressor. If needed, add oil through the plug on the side of the compressor until it becomes visible. Do not operate the compressor until the oil is visible.
- B. **AIR DRYER** - Check the air dryer for signs of leakage or other malfunctions. Check the air filter sight glass which is located on the side of the filter and drain if necessary. Blow the condenser coil ~~AND~~ clean bi-monthly. Turn on air dryer and observe that the indicator gauge on the dryer moves as it begins to function. (Run for 30 minutes before starting compressor).

**NOTE:** ONCE THESE STEPS ARE COMPLETED TURN COMPRESSOR ON.

**WARNING:** IF ANY MALFUNCTION OF THE FILTER OR DRYER IS OBSERVED, DO NOT TURN THE COMPRESSOR ON, AS CONTAMINATED AIR WILL DAMAGE THE FIGURES.

- C. **CURTAINS** - All curtains should be closed on the stage when starting the show. Inspect curtains for tears, signs of wear, unhooked hangers or ties.
- D. **PROPS** - Check that all stage props are in their proper position.
- E. **TAPE LOADING** - Thread tape onto the deck as shown on DWG. 131712 09 4002 sheet 2, Be careful to place tape through the opto-sensor. Press fast forward button and watch for the 6" of clear leader. When it passes, press stop button. Turn tape deck off for 5 seconds. Turn tape deck on. It will now start to "home" the tape automatically. The tape will be rewound past the clear leader, stop and play forward past the leader to a stop tone on the tape. When the tape stops, press the play button to start a show.

F. TEST RUN - Run a show program and observe for proper motion, light and sound of show.

NOTE: OBSERVE FOR PROPER ACTION UNTIL SHOW END.  
NEVER STOP A TAPE OR SWITCH THE TAPE DECK  
SELECT SWITCH WHEN A TAPE IS RUNNING EITHER  
DRIVE UNIT.

G. AIR - Close curtains, shut off air compressor until opening time, leave air conditioning, computer and air dryer on.

H. START-UP - At opening time, verify that the air dryer and cooling fans in mechanical room are on. Then turn on the air compressor. Press the start button to play the show. Once completed, the show will then start every 3-5 minutes for the remainder of the day. 5 IS PRESCRIBED FOR BULLWINKLE'S

I. SHOW STOP - To stop the show from operating automatically, set the deck select switch to Deck #2. Deck #2 never starts automatically, it must be started manually. Then rewind and remove the program tape from Deck #1 when it stops running.

J. TAPES - To switch tapes, wait until the tape in Deck #1 stops moving, rewind and remove it. Feed the new tape in Deck #1 and home tape. The new show can now be started immediately by pressing the play button.

K. FILTER - Clean the computer filter weekly. The filter is located on the bottom of the Show Control System (tape side). See DWG. No. 131712 09 4002 sheet 2.

?  
STILL  
CONNECTED  
?

BE VERY CAREFUL  
WITH FINGER OILS  
ON TAPE

WASH IT IN DISHWASHER &  
1. The SLOW DRY WITH  
COMPRESSED AIR  
REPLACING  
WHILE WET WILL  
DAMAGE CPU BOARD



WEEKLY!  
DAILY!

II - Periodic Maintenance

A. PRIMARY START-UP - Turn on light dimmer circuit breakers, computer room air conditioner, and computer circuit breaker. Remove all show tapes from computer area and demagnetize tape heads. Clean the tape deck heads and any other tape contact points daily using a cotton swab dipped in liquid freon TF solvent. Use Teac brand rubber conditioner on the pinchwheel. TEAC KIT.

NOTE: RADIO SHACK PART #44-1171 IS THE ONLY ACCEPTABLE REPLACEMENT TYPE SOLVENT. DO NOT USE ANY CLEANER THAT CONTAINS OTHER SOLVENTS OR LUBRICANTS. USE THE SOLVENT SPARINGLY AND USE A CLEAN SWAB FOR EACH DECK. DO NOT DIP A USED SWAB BACK INTO THE BOTTLE OF CLEANER. ALLOW ONE MINUTE FOR THE HEAD TO DRY.

DO NOT USE  
DETACHED  
ALCOHOL

B. CURTAINS - Open curtains using manual controls on the computer and <sup>visually</sup> inspect each figure for damaged skin, costume, or mechanical parts. Remove any obstructions that are on the curtain drive assemblies. Vacuum curtains as needed (at least <sup>ONCE</sup> ~~one~~ each 8 weeks).

C. FIGURES - Making sure technician's hands are clean, apply pressure to each figure's hands, arms, head, torso, etc. to check for loose or worn linkages. Brush and comb fur as needed to remove fur balls and lint. Dust clothing as needed being careful not to damage any of the fur. Brush dust from skin using a soft paint brush. Do not use any liquids or other cleaners on skins except soap and water as needed. Once dusted, sprinkle skin lightly with talcum powder to help it retain its moisture. Skin should be powdered weekly.

REVISE/  
OMIT

}  
?  
?  
?

D. LUBRICATION AND MECHANICAL REPAIRS - Each figure should be opened once a month for inspection and lubrication. Turn off air compressor and locate access panel(s) on figures. Remove panel(s) and repair any damage. Use Loctite when re-assembling.

7  
0 — Check all other linkages, bolts, etc., for tightness.  
Grease all rod ends and bearings that have grease fittings. Be careful not to over grease. The actuators do not need lubrication as they are packed internally with teflon lubricant.

NOTE: THE ACTUATOR LUBRICANT IS GREEN IN COLOR AND IS TOXIC, AVOID CONTACT WITH IT. 

E. STAGE FLOOR - Be sure all props are in correct position and carefully vacuum stage, props, and costumes weekly.

F. DAILY CHECK LIST - Use ~~Xerox~~ <sup>ALOTO</sup> copies of the daily check list to assure proper show operation, and maintain a record of maintenance.

ANIMATION CHECK LIST

CHECKED BY \_\_\_\_\_ DATE \_\_\_\_\_

FIGURE: CURTAINS

FUNCTION

COMMENTS

LEFT STAGE OPEN / *CLOSE*

~~LEFT STAGE CLOSE~~

CENTER STAGE OPEN / *CLOSE*

~~CENTER STAGE CLOSE~~

RIGHT STAGE OPEN / *CLOSE*

~~RIGHT STAGE CLOSE~~

DAILY ANIMATION CHECKLIST

CHECKED BY: \_\_\_\_\_ DATE \_\_\_\_\_

FIGURE: DUDLEY

	<u>FUNCTION</u>	<u>COMMENTS</u>
<input type="checkbox"/>	EYE BROWS	
<input type="checkbox"/>	EYE BLINK	
<input type="checkbox"/>	EYES LEFT	
<input type="checkbox"/>	EYES RIGHT	
<input type="checkbox"/>	MOUTH	
<input type="checkbox"/>	HEAD NOD	
<input type="checkbox"/>	HEAD TURN	
<input type="checkbox"/>	LEFT SHOULDER F/B	
<input type="checkbox"/>	<del>LEFT</del> ARM I/O	
<input type="checkbox"/>	LEFT ELBOW OUT	
<input type="checkbox"/>	HIP TWIST RIGHT	
<input type="checkbox"/>	HOP TWIST LEFT	
<input checked="" type="checkbox"/>	GRAMA PHONE	
<input checked="" type="checkbox"/>	LIGHTS	

DAILY ANIMATION CHECK LIST

CHECKED BY: \_\_\_\_\_ DATE \_\_\_\_\_

FIGURE: HOPPITY HOOPER

<u>FUNCTION</u>	<u>COMMENTS</u>
<input type="checkbox"/> EYES RIGHT	<input type="checkbox"/>
<input type="checkbox"/> EYES LEFT	<input type="checkbox"/>
<input type="checkbox"/> HARMONICA RIGHT	<input type="checkbox"/>
<input type="checkbox"/> HARMONICA LEFT	<input type="checkbox"/>
<input type="checkbox"/> BODY TWIST	<input type="checkbox"/>
<input checked="" type="checkbox"/> LIGHT	<input type="checkbox"/>
	<input type="checkbox"/>
	<input type="checkbox"/>
	<input type="checkbox"/>
	<input type="checkbox"/>
	<input type="checkbox"/>
	<input type="checkbox"/>
	<input type="checkbox"/>

DAILY ANIMATION CHECK LIST

CHECKED BY: \_\_\_\_\_ DATE \_\_\_\_\_

FIGURE: ROCKY

FUNCTION	COMMENTS
<input data-bbox="181 466 256 533" type="checkbox"/> EYE BLINK	<input data-bbox="1310 414 1385 482" type="checkbox"/>
<input data-bbox="181 558 256 625" type="checkbox"/> EYES LEFT	<input data-bbox="1310 506 1385 574" type="checkbox"/>
<input data-bbox="181 649 256 717" type="checkbox"/> EYES RIGHT	<input data-bbox="1310 598 1385 666" type="checkbox"/>
<input data-bbox="181 741 256 809" type="checkbox"/> MOUTH	<input data-bbox="1310 690 1385 758" type="checkbox"/>
<input data-bbox="181 844 256 911" type="checkbox"/> HEAD TILT RIGHT	<input data-bbox="1310 782 1385 850" type="checkbox"/>
<input data-bbox="181 936 256 1003" type="checkbox"/> HEAD TILT LEFT	<input data-bbox="1310 874 1385 942" type="checkbox"/>
<input data-bbox="181 1038 256 1105" type="checkbox"/> HEAD TURN	
<input data-bbox="181 1130 256 1197" type="checkbox"/> RIGHT ARM SLIDE	
<input data-bbox="181 1232 256 1299" type="checkbox"/> RIGHT FINGERS	
<input data-bbox="181 1324 256 1391" type="checkbox"/> LEFT ARM I/O	

DAILY ANIMATION CHECKLIST

CHECKED BY: \_\_\_\_\_ DATE \_\_\_\_\_

FIGURE: TOOTER TURTLE

<u>FUNCTION</u>	<u>COMMENTS</u>
<input type="checkbox"/> EYES BLINK	<input type="checkbox"/>
<input type="checkbox"/> EYES LEFT	<input type="checkbox"/>
<input type="checkbox"/> EYES RIGHT	<input type="checkbox"/>
<input type="checkbox"/> MOUTH	<input type="checkbox"/>
<input type="checkbox"/> HEAD TURN	<input type="checkbox"/>
<input type="checkbox"/> RIGHT WRIST	<input type="checkbox"/>
<input type="checkbox"/> LEFT WRIST	<input type="checkbox"/>
	<input type="checkbox"/>
	<input type="checkbox"/>
	<input type="checkbox"/>
	<input type="checkbox"/>
	<input type="checkbox"/>
	<input type="checkbox"/>
	<input type="checkbox"/>
	<input type="checkbox"/>
	<input type="checkbox"/>
	<input type="checkbox"/>
	<input type="checkbox"/>

DAILY ANIMATION CHECK LIST

CHECKED BY \_\_\_\_\_ DATE \_\_\_\_\_

FIGURE: BULLWINKLE

FUNCTION	COMMENTS
<input type="checkbox"/> EYE BROWS	
<input type="checkbox"/> EYE BLINK	
<input type="checkbox"/> EYES RIGHT	
<input type="checkbox"/> EYES LEFT	
<input type="checkbox"/> EYES UP	
<input type="checkbox"/> EYES DOWN	
<input type="checkbox"/> MOUTH	
<input type="checkbox"/> HEAD NOD UP	
<input type="checkbox"/> HEAD NOD DOWN	
<input type="checkbox"/> HEAD TURN	
<input type="checkbox"/> HEAD TILT RIGHT	
<input type="checkbox"/> HEAD TURN LEFT	
<input type="checkbox"/> RIGHT FOOT TAP	
<input type="checkbox"/> LEFT ARM SLIDE IN	
<input type="checkbox"/> LEFT ARM SLIDE OUT	



DAILY ANIMATION CHECKLIST

CHECKED BY \_\_\_\_\_ DATE \_\_\_\_\_

FIGURE: BULLWINKLE (cont)

FUNCTION

COMMENTS

RIGHT WRIST U/D

LEFT FINGERS

BANJO UP/DOWN

BODY ROCK

DAILY ANIMATION CHECK LIST

CHECKED BY: \_\_\_\_\_ DATE \_\_\_\_\_

FIGURE: UNDERDOG

FUNCTION	COMMENTS
<input data-bbox="183 429 255 500" type="checkbox"/> EYE BROWS	
<input data-bbox="183 521 255 592" type="checkbox"/> EYE BLINK	
<input data-bbox="183 613 255 684" type="checkbox"/> EYES RIGHT	
<input data-bbox="183 705 255 776" type="checkbox"/> EYES LEFT	
<input data-bbox="183 797 255 868" type="checkbox"/> EYES UP	
<input data-bbox="183 889 255 960" type="checkbox"/> EYES DOWN	
<input data-bbox="183 981 255 1052" type="checkbox"/> MOUTH	
<input data-bbox="183 1073 255 1144" type="checkbox"/> HEAD NOD	
<input data-bbox="183 1165 255 1236" type="checkbox"/> BODY F/B	
<input data-bbox="183 1257 255 1328" type="checkbox"/> SAX UP/DOWN	
<input data-bbox="183 1349 255 1420" type="checkbox"/> HAND FINGER 1	
<input data-bbox="183 1441 255 1512" type="checkbox"/> RIGHT HAND FINGER 2	
<input data-bbox="183 1533 255 1604" type="checkbox"/> TORSO TWIST	

DAILY ANIMATION CHECK LIST

CHECKED BY: \_\_\_\_\_ DATE \_\_\_\_\_

FIGURE: NATASHA

FUNCTION:

COMMENTS

EYES RIGHT

EYES LEFT

MOUTH

DAILY ANIMATION CHECK LIST

CHECKED BY: \_\_\_\_\_ DATE

FIGURE: BORIS

FUNCTION

COMMENTS

EYES RIGHT

EYES LEFT

MOUTH

DAILY ANIMATION CHECK LIST

CHECKED BY: \_\_\_\_\_ DATE \_\_\_\_\_

FIGURE: SNIDELY

FUNCTION	COMMENTS
<input data-bbox="212 496 284 564" type="checkbox"/> EYE BROWS	<input data-bbox="1289 400 1361 468" type="checkbox"/>
<input data-bbox="212 588 284 656" type="checkbox"/> EYE BLINK	<input data-bbox="1289 492 1361 560" type="checkbox"/>
<input data-bbox="212 680 284 748" type="checkbox"/> EYES RIGHT	<input data-bbox="1289 584 1361 652" type="checkbox"/>
<input data-bbox="212 782 284 850" type="checkbox"/> EYES LEFT	<input data-bbox="1289 676 1361 744" type="checkbox"/>
<input data-bbox="212 874 284 942" type="checkbox"/> MOUTH	<input data-bbox="1289 768 1361 835" type="checkbox"/>
<input data-bbox="212 966 284 1034" type="checkbox"/> HEAD TURN RIGHT	<input data-bbox="1289 860 1361 927" type="checkbox"/>
<input data-bbox="212 1064 284 1132" type="checkbox"/> HEAD TURN LEFT	<input data-bbox="1289 952 1361 1019" type="checkbox"/>
<input data-bbox="212 1156 284 1224" type="checkbox"/> SIGN TILT	<input data-bbox="1289 1044 1361 1111" type="checkbox"/>

DAILY ANIMATION CHECKLIST

CHECKED BY: \_\_\_\_\_ DATE: \_\_\_\_\_

FIGURE: WATER SHOW

FUNCTION:

COMMENTS

- ROW 1
- ROW 2
- CAKE 1
- CAKE 2
- CAKE 3
- CAKE CENTER
- SYNC JETS
- SPINNER JETS
- BACK ROW
- FANS
- LEFT TRUNION
- RIGHT TRUNION
- LEFT ARCH
- RIGHT ARCH
- SPINNER MOTOR

DAILY ANIMATION CHECK LIST

CHECKED BY \_\_\_\_\_ DATE \_\_\_\_\_

FIGURE: WATER SHOW (Cont)

FUNCTION	COMMENTS
<input type="checkbox"/> PUMP 1	
<input type="checkbox"/> PUMP 2	
<input type="checkbox"/> ANALOG MOTOR	
<input type="checkbox"/> TRUNION PARK	

### III - Emergency Procedures

- A. **POWER FAILURE WHILE THE SHOW IS RUNNING** - Turn the circuit breaker to the computer and the power switch to the air compressor off. When power is restored turn the computer back on. Turn the air compressor on and allow it to build to 100 PSI before starting the show. Once show has been restarted it should function properly.
- B. **LEAKING AIR** - When the tape stops, turn computer off. Identify which figure, and in what area of the figure the leak is occurring. Turn ball shut-off valve to the off position. Remove the access panel to the area of the leak and look for disconnected or ruptured air lines. If necessary, turn the ball valve back on to find the source of the leak. If a hose has popped out of a fitting, cut off  $\frac{1}{2}$  inch of the hose and firmly reinsert it into the fitting. On the small brown air line, be sure to reinstall the brass ring that holds the air line onto the fitting. If a hose has ruptured, determine if the ruptured area can be cut off with enough hose remaining to reach the fitting. If not, replace the entire length of hose. Always make sure that the hose is properly tied off so that it does not rub, and has enough slack to follow the figure's movements. If a temporary repair cannot be made, turn off the computer bit to that particular function, plug the leak at the rupture and operate the show with that function motionless until a repair can be made.

— NO —  
SPICE ON A  
NEW LENGTH



#### IV - Plastics Maintenance

##### A. URETHANE FOAM PARTS

- (1) Use soap and water only to clean. Solvents remove paints and may damage foam.
- (2) For minor or emergency repairs use auto body repair filler or Superglue (cyanoacrylate) on Rigid foam. Superglue may be used on Flex Foams or Smooth-On Skin. Fiberglass boat tape and Devcon Epoxy are used on Rimspray. First clean and sand area to be repaired on back side of part. Repair small cracks with Superglue.

MILD WINDOW CLEANER  
MAY BE SPRAYED ON  
& WIPED OFF GENTLY

##### (3) Types of Foam

Rimspray -10 FR

Skins - Smooth-On Urethane

Flex Black Foam - FX 111

Flex Yellow Foam - F 2800

Flex White Foam - 218

Rigid Foam - 20-10

TYPICAL USES  
FENCE & RAILS  
BULLWINKLE'S FACE

NOTE: CALL AVG FOR INFORMATION WHENEVER REPAIR IS MAJOR, OR THERE ARE ANY QUESTIONS

##### B. POLYESTER FIBERGLASS PARTS

- (1) Small cracks can be repaired with Superglue. To make an emergency repair, use Polyester Fiberglass repair kit or auto body repair filler after cleaning and sanding area to be repaired.

##### C. BUTYRATE PARTS

- (1) Clean with soap and water only. Keep parts away from heat as heat distorts the shape.
- (2) A crack may be stopped by drilling a hole at the end of the crack. Then use Superglue and a thin strip of plastic on the underside to rejoin crack.

## V - Cosmetics Maintenance

### A. PAINTS USED ON BULLWINKLE SHOW

- a. **POLYURETHANE A** - An air dry clear base to which pigment is added at approximately one teaspoon (pigment) to 8 ounces (a). This mixture may be thinned with M.E.K. for spraying. Drying time is approximately one hour.
- b. **POLYURETHANE B** - An air dry clear base to which pigment is added at approximately one tablespoon (pigment) to 8 ounces (b). Thinning should not be necessary, but can be done with M.E.K. Drying time is approximately 24 hours, 48 in colder environments. Apply in thin coats.
- c. **LACQUER** - An air dry clear base to which desired pigment is added at approximately one teaspoon (pigment) to 8 ounces (Lacquer). To spray, thin with Lacquer thinner at 2/3 Lacquer to 1/3 thinner. Drying time is approximately one hour.
- d. **ACRYLIC** - An air dry water base paint. Thin with water if desired.
- e. **POLYURETHANE CLEAR SATIN** - Used to seal objects painted with acrylic. Can be thinned with paint thinner. Drying time is approximately 16 hours.
- f. **URETHANE PIGMENTS** - Assorted colors.

**NOTE:** TO ACHIEVE PROPER EFFECT, TOUCH UPS ON ALL FIGURES SHOULD BE DONE WITH AN AIR BRUSH. ANY PAINT SUPPLIED BY AVG WILL BE COLOR MATCHED.

### B. PAINTS USED PER FIGURE

#### 1. DUDLEY

Head	(c)
Eyelids	(c)
Teeth	(c)
Legs	(a)

- |    |                   |     |
|----|-------------------|-----|
|    | Arms              | (a) |
|    | Brows             | (a) |
| 2. | <b>HOPPITY</b>    |     |
|    | Head/Body         | (a) |
|    | Arms              | (a) |
|    | Legs              | (a) |
|    | Harmonica         | (a) |
| 3. | <b>ROCKY</b>      |     |
|    | Head              | (b) |
|    | Body              | (a) |
|    | Arms              | (b) |
|    | Eyelids           | (a) |
|    | Fiddle            | (a) |
| 4. | <b>TOOTER</b>     |     |
|    | Head              | (c) |
|    | Body              | (b) |
|    | Arms              | (b) |
|    | Legs              | (b) |
|    | Eyelids           | (c) |
|    | Drums/Sticks      | (a) |
| 5. | <b>BULLWINKLE</b> |     |
|    | Head              | (b) |
|    | Antlers           | (a) |
|    | Eyelids           | (c) |
|    | Arms              | (b) |
|    | Legs              | (a) |
|    | Banjo             | (a) |
| 6. | <b>UNDERDOG</b>   |     |
|    | Head              | (c) |
|    | Arms              | (b) |
|    | Legs              | (a) |
|    | Eyelids           | (c) |
|    | Sax               | (a) |
| 7. | <b>SNIDELY</b>    |     |
|    | Head              | (c) |
|    | Eyelids           | (c) |

Arms (a)  
Legs (a)

8. STAGE

All Wood (d,e)  
All Fencing (d,e)  
Boris and Natasha (d,e)  
All Interior Signs (d,e)

## VI - Costume Maintenance

*This is for walk-around*

### A. GENERAL MAINTENANCE

All costumes and hats are removable for maintenance and repair. Many of the costumes are commercially dry cleanable. *[Refer to section on each costume for information on how to maintain that particular costume.]*

The costumes are all treated with *Scotchguard during production* and must be retreated for stain resistance after dry cleaning either by the drycleaners or by the maintenance crew.

Costumes constructed with foam should not be dry cleaned. They may be hand washed, with care given not to saturate foam. Be sure to retreat garment with scotchguard after cleaning.

Hats must not be drycleaned. They can be wiped with a damp cloth and dusted or blown out with an air hose. Do not use dry cleaning solution or solvents on the hats. Never expose the hats to direct heat or steam.

Fur should not be dry cleaned. Use a damp cloth for spot removal. Use a wide-toothed comb or brush designed for use on animal hair.

### B. INDIVIDUAL COSTUMES

- (1) **BULLWINKLE** - Jacket must be dry cleaned. Check with the cleaner to be sure that their cleaning methods are safe for the fur collar and cuffs. The pants and dickie are dry cleanable only. The head and leg fur may be hand washed if necessary with Woolite in cool water. Do not dry clean fur.
- (2) **ROCKY** - Rocky's scarf may be dry cleaned. The hat should not be cleaned. If soiled, wipe with a damp cloth. Rocky's tail should not require cleaning, brush with a wide-toothed comb if fur becomes matted.

- (3) **DUDLEY** - Dudley's jacket and pants must be dry cleaned only. Do not clean Dudley's hat or belt.
- (4) **HOPPITY HOOPER** - The shirt may be dry cleaned or hand washed. The lederhosen may be wiped clean with a damp cloth.
- (5) **SNIDELY** - Snidely's jacket is dry cleanable only. Snidely's hat can be wiped clean with a damp cloth.
- (6) **TOOTER TURTLE** - Tooter's ski cap can be hand washed, machine washed in delicate cycle or dry cleaned. Tooter's collar and cuffs should only be cleaned by wiping with a damp cloth.
- (7) **UNDERDOG** - Underdog's suit and cape are dry cleanable only.

## CHAPTER 4

### TROUBLE SHOOTING

#### I - General Trouble Shooting Procedures

- A. **AIR SUPPLY** - If the show program is running, but the figures are not moving, check the air supply at the compressor and at the gauge on the air regulator. It should be between 120 and 150 PSI at the compressor, and 90 and 100 PSI at the regulator. If the pressure is below 120 PSI, the compressor should be running. If the compressor is not running, check the power switch on the wall box and the power switch on the control panel. If the compressor still does not run, check for blown fuses in the disconnect box and at the main power supply and for 208 VAC between all three legs of the supply voltage at the compressor.
- B. **TAPE DECK** - Isolate operation problems by using the manual switches on the computer front panel. If any of the functions will move manually, check that the proper tape deck is selected. Allow the tape to play until it stops by itself, turn the computer off at the circuit breaker and then turn it back on. Wait until deck resets itself and press the start button on the selected tape deck. At that time the show should operate correctly. If not, repeat the above procedure using a different tape or using the same show tape on the other deck.
- C. **FUNCTION CHECK** - If the function does not work manually, check the computer for blown fuses on I/O panel and I/O power supply. Activate digital valves by pressing the white plastic solenoid plunger located on each valve in the base of each figure. Activate analog functions using the local switch and test pot located on the servo card in the figure control boxes (refer to servo card

illustration). Check mechanical linkages for binding or failure. Adjust the flow controls for any digital function that actuates either too fast or too slow. Flow controls are mounted inside the figures in pairs, with one controlling the outward speed of the actuator, and the other controlling the inward speed of the actuator. It is usually better to adjust these while actually playing a show tape for the best appearing results. After installing actuator adjust servo card or flow controls.

**D. LINEAR FEEDBACK POT REMOVAL AND REPLACEMENT -**

Unplug feedback connector and cut off tie wraps. Loosen both feedback clamps. **Note the position for replacement.** Remove feedback pot. Before mounting new pot make sure it functions properly. To do this you must complete the following steps.

- (1) Set ohm meter on RX 100 and connect the positive wire to the orange feedback wire. Then connect the negative to the red feedback wire.
- (2) Check the tracking of the feedback pot from 0 to 50K, looking for any sudden jump. **(NOTE: ANY SUDDEN JUMP IN THE FEEDBACK IS NOT ACCEPTABLE).**
- (3) Then take the negative wire and disconnect it from the red feedback wire and connect it to the black feedback wire. Repeat step 2.
- (4) If the feedback is acceptable you can mount it.

To mount a new feedback pot, make sure the actuator is retracted all the way. Mount the feedback pot to the actuator tube. The clamp must be mounted on either end (bottom or top end) of the body. Tighten down, but not too



tightly, being careful not to crush it. Mount the feedback shaft clamp about 1/16" above the actuator end cap and the feedback shaft step approximately 1/16" from the top of the feedback body. Tighten the set screws. **(NOTE: THE FEEDBACK SHAFT MUST BE PARALLEL WITH THE ACTUATOR SHAFT).** Once the pot is mounted, reconnect the feedback connector. (Make sure the color of the wires line up). Then tie wrap the wires as originally wrapped.

**E. ROTARY FEEDBACK POT REMOVAL AND REPLACEMENT -**

Unplug feedback connector and cut off tie wraps. Loosen set screw inside actuator shaft. Loosen body clamp screw, and remove pot. Before mounting feedback make sure it functions properly. To do this you must follow these steps:

- (1) Set ohm meter on RX 100 and connect the ohm meter positive wire with the orange feedback wire. Then connect the negative wire to the red feedback wire.
- (2) Check the tracking of the feedback from 0 to 10K. Do this by manually rotating the shaft on the feedback in between 0 and 10K, looking for any sudden jump. **(NOTE: ANY SUDDEN JUMP INDICATES THE POT IS FAULTY).**
- (3) Disconnect the negative wire from the red feedback wire and connect it to the black feedback wire.
- (4) Repeat step 2.

Mount feedback pot to rotary actuator.

Tighten set screw in actuator shaft. Leave feedback body snug but moveable. By manually rotating the actuator shaft right then left find the low reading. Then find and note the high reading.

Next take the negative wire and disconnect it from the black feedback wire. Connect the negative wire to the red feedback wire. Rotate the actuator shaft manually to find the low and high readings. (NOTE: THE LOW READING SHOULD BE THE SAME FOR BOTH RED AND BLACK FEEDBACK WIRES. IF NOT, ROTATE THE FEEDBACK BODY UNTIL THEY BOTH MATCH. RECHECK THE HIGH AND LOW READINGS AS NECESSARY. THE HIGH READING SHOULD NOW BE NEARLY THE SAME FOR BOTH RED AND BLACK WIRES). Tighten down the screw on the body clamp. Plug the feedback connector in and tie wrap the wire as it was before.

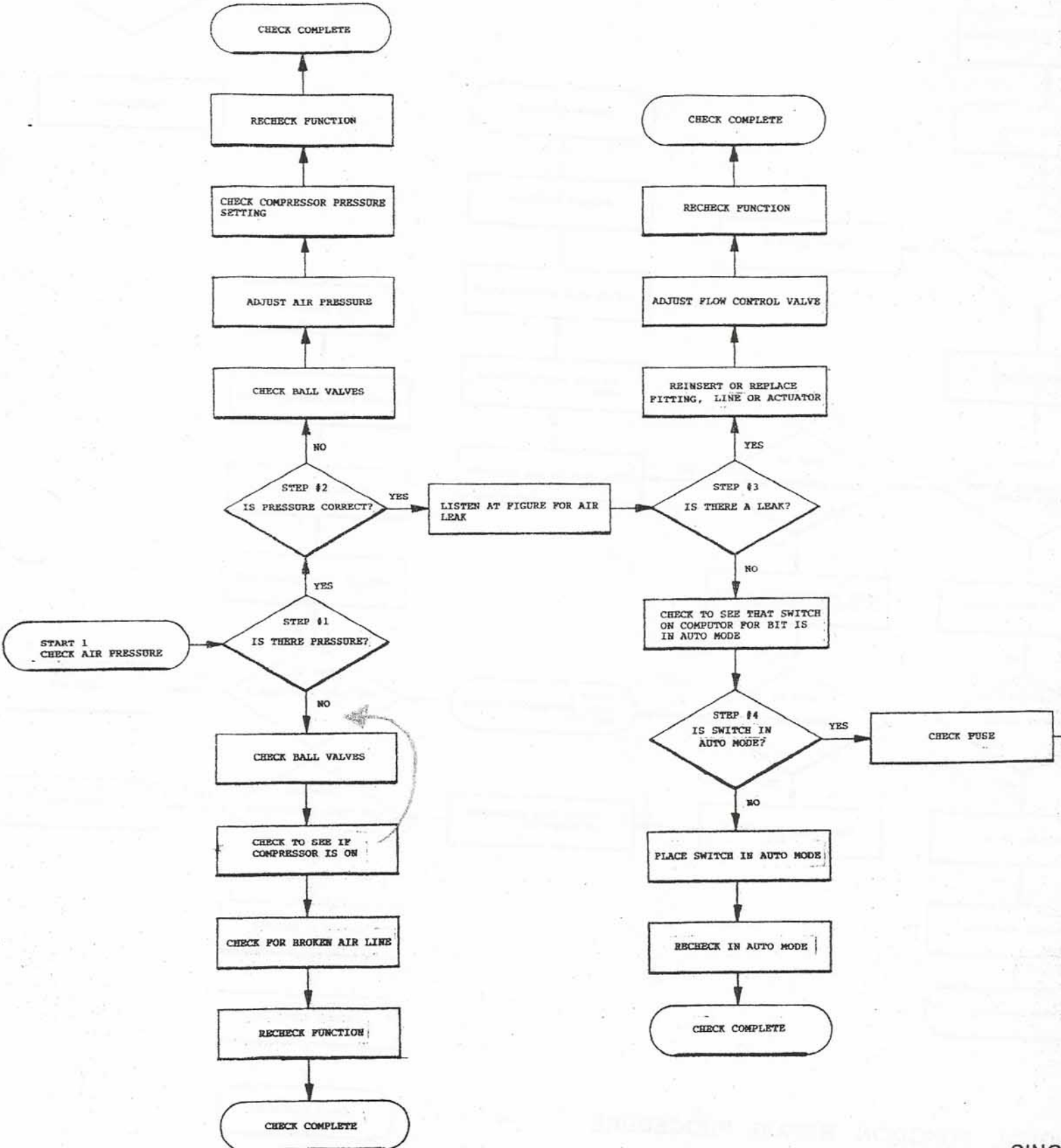

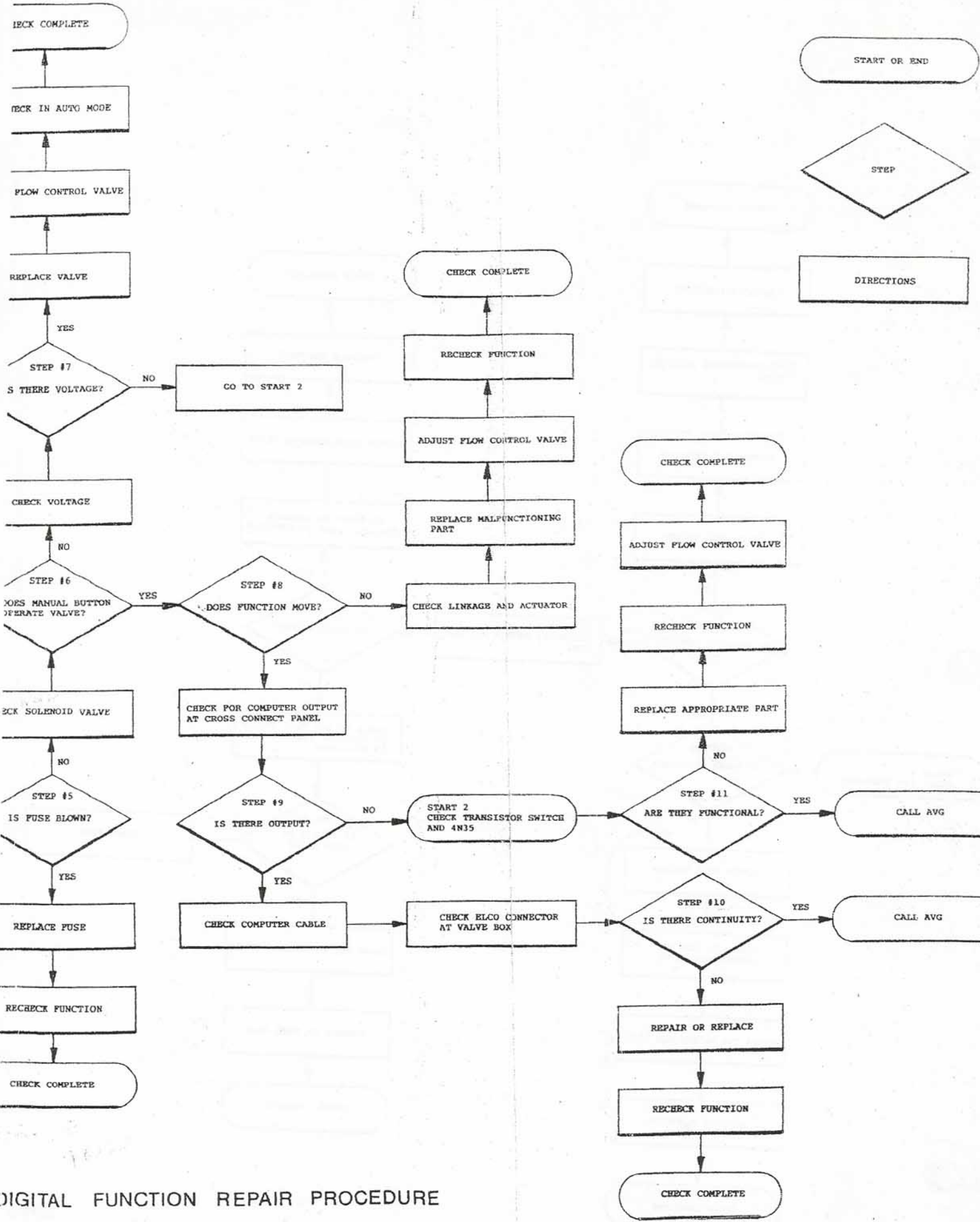

DIGITAL FUNCTION REPAIR PROCEDURE

## II - DIGITAL FUNCTION TROUBLE SHOOTING GUIDE

### START 1 - CHECK AIR PRESSURE.

**STEP 1 - IS THERE PRESSURE?** Is there pressure at the figure? If yes, proceed to STEP 2. If no, check the ball shut-off valve under the stage and make sure it is open. If it is, check to see if the compressor is on. If it is, check the complete air supply route for ruptures or cracks. If any are found, repair and recheck the function.

**STEP 2 - IS PRESSURE CORRECT?** Is the air pressure at 100 PSI at the air regulator? If it is, listen for an air leak at the figure and proceed to STEP 3. If it isn't, check the ball shut-off valves under the stage and make sure they are in a completely open position. Adjust the air pressure at the air regulator to 100 PSI. If this doesn't correct the pressure, check the compressor pressure setting at the automatic start/stop and make sure it is at 110 PSI start and 150 PSI stop. If it isn't, adjust it accordingly and recheck the function.

**STEP 3 - IS THERE A LEAK?** Is there a leak at the figure? If there is, determine the location and re-insert or replace the fitting, line, or actuator as needed. If the actuator is replaced, adjust the flow control valve and recheck the function. If there is no leak at the figure, check to see that the computer bit switch for the function is in auto mode and recheck the function.

**STEP 4 - IS SWITCH IN AUTO MODE?** Is the computer bit switch for the function in auto mode? If yes, check the fuse on the digital I/O panel and proceed to STEP 5. If not, place the switch in auto mode and recheck the function.

**STEP 5 - IS FUSE BLOWN?** Is the fuse on the I/O panel or the fuse on the back of I/O power supply panel blown? If not, check the 4-way solenoid valve at the base of the figure and proceed to STEP 6. If a fuse is blown, replace it and recheck the function.

**STEP 6 - DOES MANUAL BUTTON OPERATE VALVE?** Does the small white button on the solenoid valve operate the valve? If it does, proceed to STEP 8. If it doesn't check the voltage at the Elco connector to the valve at the valve box.

**STEP 7 - IS THERE VOLTAGE?** Is there any voltage at the Elco connector to the solenoid valve? If there isn't proceed to START 2. If there is, replace the solenoid valve, adjust the flow control valve, and recheck the function in auto mode.

**STEP 8 - DOES FUNCTION MOVE?** Does the small white button on the solenoid valve operate and does the function move? If yes, turn the computer bit switch for the function off and check the pin pair in the Elco connector for 24 VDC. Turn the computer bit switch on and check for DC voltage again. Proceed to STEP 9. If the function does not move when the manual button on the solenoid valve is depressed, check the linkage and the actuator at the figure. Replace the malfunctioning part(s), adjust the flow control valve, and recheck the function.

**STEP 9 - IS THERE OUTPUT?** Is there DC voltage at the pin pair in the Elco connector? There should be no voltage with the computer bit switch turned off, and the voltage should be at 24 VDC with the computer bit switch turned on. If there is no voltage at all, proceed to START 2. If there is voltage, check the figure data control cable for continuity or any breaks and then check the Elco connector at the valve box at the base of the figure for same.

**STEP 10 - IS THERE CONTINUITY?** Is there continuity in the figure data control cable and the Elco connector? If yes, call the Customer Service Manager at AVG Productions, Inc. If not, repair any breaks or replace the figure data control cable or Elco connector as needed and recheck the function.

**START 2 - CHECK TRANSISTOR, SWITCH, AND 4N35.**

**STEP 11 - ARE THEY FUNCTIONAL?** Do the MJE521 transistor on the digital I/O panel, the 4N35 semiconductor next to it, work? If yes, call the Customer Service Manager at AVG Productions, Inc. If not, replace the appropriate part(s), recheck the function, and adjust the flow control valve.

**CHECK COMPLETE**

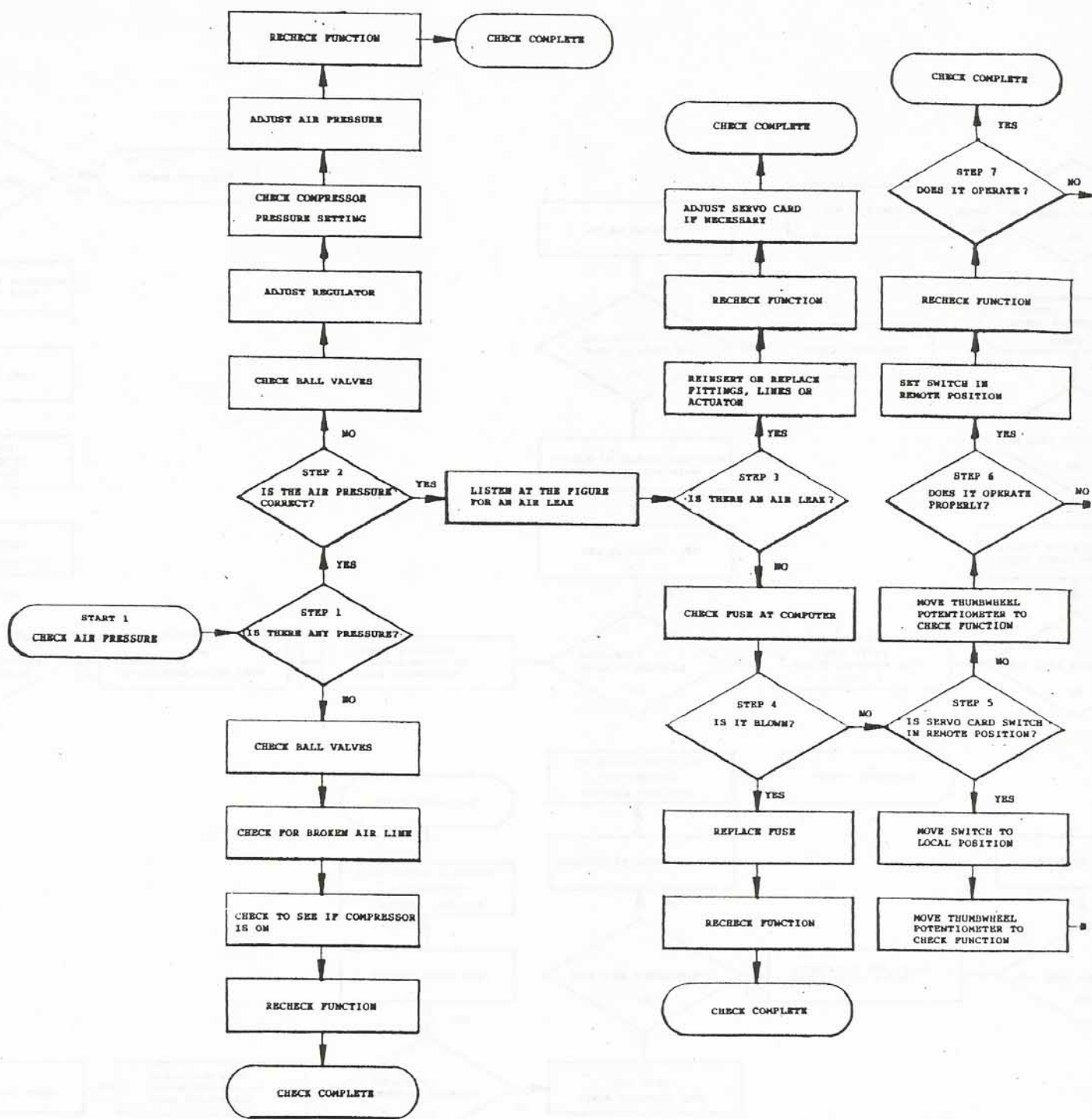

START OR END

STEP

DIRECTIONS

GO TO START 1



# SINGLE ANALOG FUNCTION REPAIR PROCEDURE

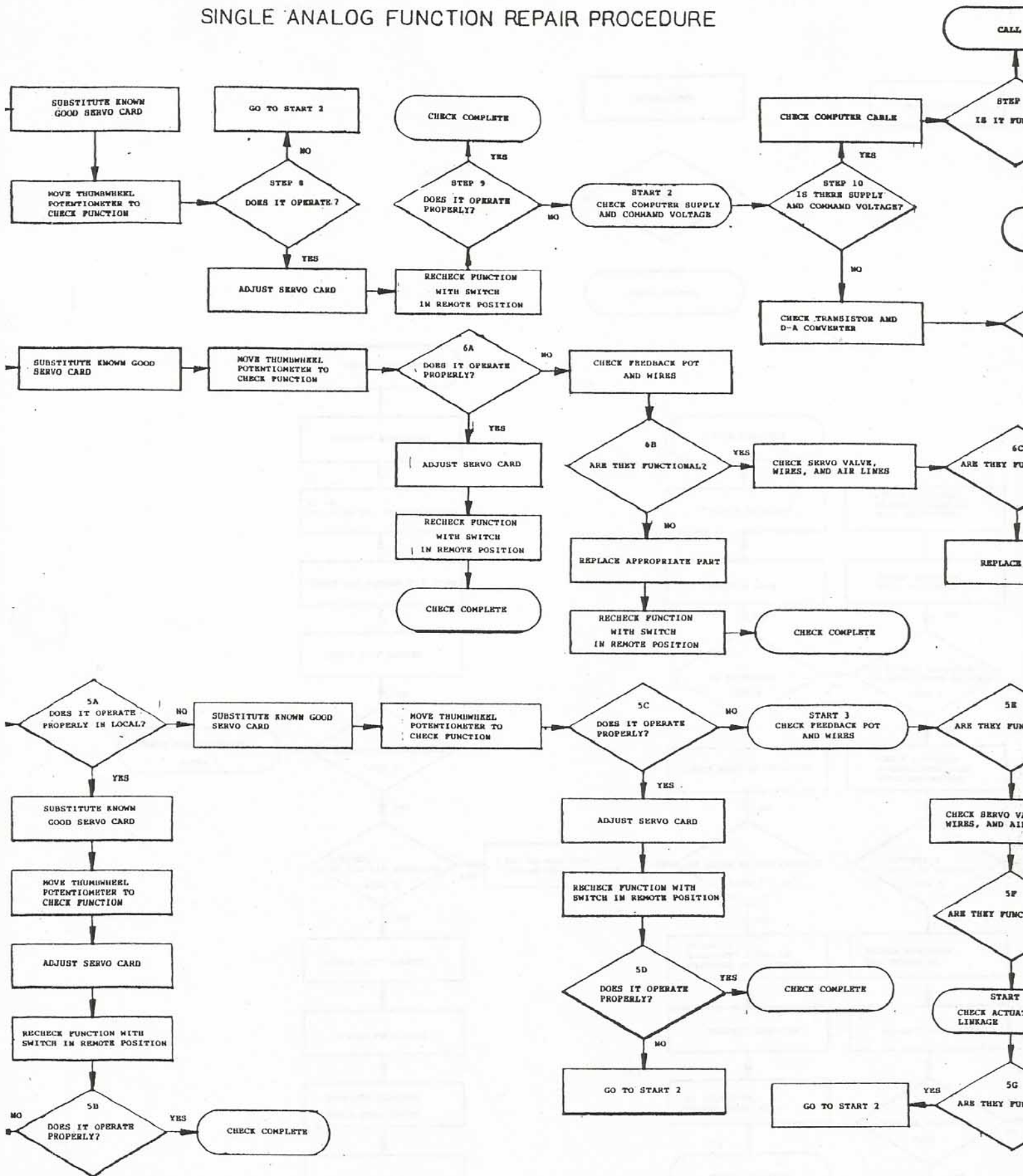

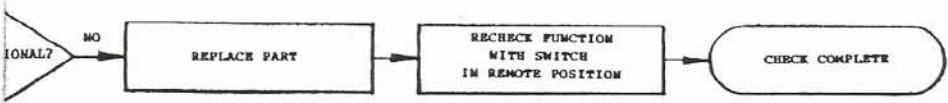
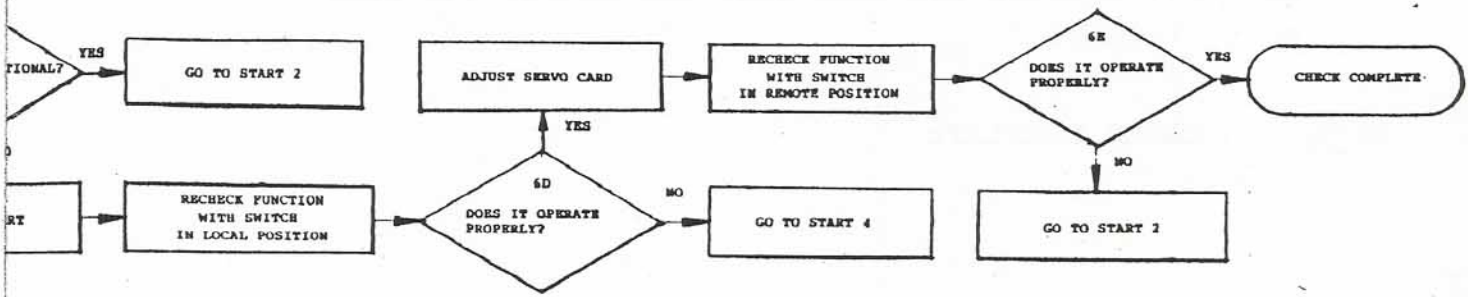
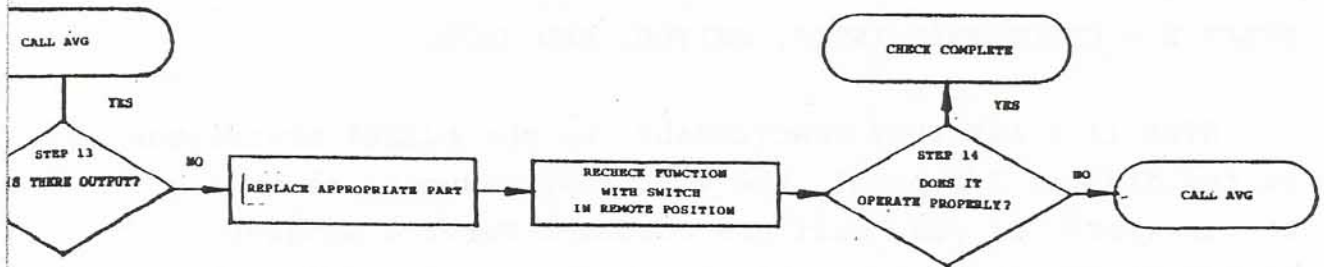
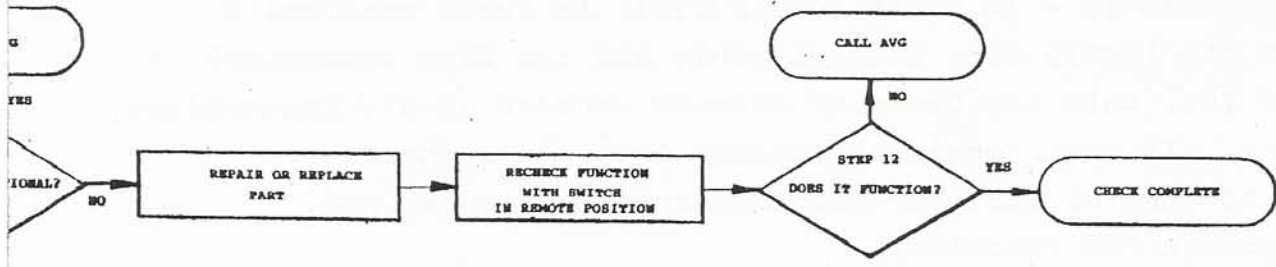

ES

E. TIMES

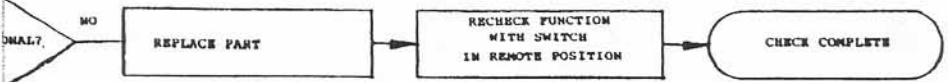

AND

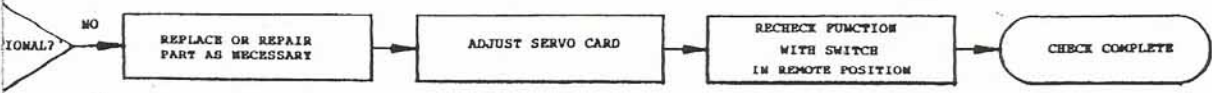

**STEP 10 - IS THERE CONTINUITY?** Is there continuity in the figure data control cable and the Elco connector? If yes, call the Customer Service Manager at AVG Productions, Inc. If not, repair any breaks or replace the figure data control cable or Elco connector as needed and recheck the function.

**START 2 - CHECK TRANSISTOR, SWITCH, AND 4N35.**

**STEP 11 - ARE THEY FUNCTIONAL?** Do the MJE521 transistor on the digital I/O panel, the 4N35 semiconductor next to it, work? If yes, call the Customer Service Manager at AVG Productions, Inc. If not, replace the appropriate part(s), recheck the function, and adjust the flow control valve.

**CHECK COMPLETE**

### III - ANALOG FUNCTION TROUBLE SHOOTING GUIDE

#### START 1 - CHECK AIR PRESSURE.

**STEP 1 - IS THERE PRESSURE?** Is there pressure at the figure? If yes, proceed to STEP 2. If no, check the ball shut-off valve under the stage and make sure it is open. If it is, check to see if the compressor is on. If it is, check the complete air supply route for ruptures or cracks. If any are found, repair and recheck the function.

**STEP 2 - IS PRESSURE CORRECT?** Is the air pressure at 100 PSI at the air regulator? If it is, listen for an air leak at the figure and proceed to STEP 3. If it isn't, check the ball shut-off valves under the stage and make sure they are in a completely open position. Adjust the air pressure at the air regulator to 100 PSI. If this doesn't correct the pressure, check the compressor pressure setting at the automatic start/stop and make sure it is at 110 PSI start and 150 PSI stop. If it isn't, adjust it accordingly and recheck the function.

**STEP 3 - IS THERE A LEAK?** Is there a leak at the figure? If there is, determine the location and re-insert or replace the fitting, line, or actuator as needed. If the actuator is replaced, adjust the servo card and recheck the function. If there is no leak at the figure, go to STEP 4.

**STEP 4 - IS IT BLOWN?** Is the fuse on the analog I/O panel, or the fuse on the back I/O power supply panel, blown? If not, proceed to STEP 5. If either fuse is blown, replace it and recheck the function.

**STEP 5 - IS SERVO CARD SWITCH IN REMOTE POSITION?** Is the switch on the servo card for that function in the remote position? If not, rotate the thumbwheel potentiometer to check the function and proceed to STEP 6. If yes, move the switch to the local position, rotate the thumbwheel to check the function and proceed to STEP 5A.

**STEP 5A - DOES IT OPERATE PROPERLY IN LOCAL?**

Does the function operate properly with the servo card switch in the local position? If not, substitute a known good servo card, (See: Servo Card Adjustment Procedure), check the function by moving the thumbwheel, and proceed to STEP 5C. If the function does operate properly in local, substitute a known good servo card and check the function by rotating the thumbwheel. Adjust the servo card and recheck the function with the servo card switch in the remote position. Proceed to STEP 5B.

**STEP 5B - DOES IT OPERATE PROPERLY?** Does the function operate properly with the servo card switch in the remote position? If not, proceed to START 3.

**STEP 5C - DOES IT OPERATE PROPERLY?** Does the function operate properly with a new servo card? If not, proceed to START 3. If it does, adjust the servo card and recheck the function with the servo card switch in the remote position. Proceed to STEP 5D.

**STEP 5D - DOES IT OPERATE PROPERLY?** Does the function operate properly in the remote position with a new adjusted servo card? If not, proceed to START 2.

**START 3 - CHECK FEEDBACK POT AND WIRES.**

**STEP 5E - ARE THEY FUNCTIONAL?** Are the wires for that function's feedback pot intact and does the pot function? If not, replace the necessary part and recheck the function with the servo card switch in the remote position. If they are intact, check the servo valve and its wires and air lines. Proceed to STEP 5F.

**STEP 5F - ARE THEY FUNCTIONAL?** Are the servo valve, its wires and air lines, intact? If not, replace the necessary part and recheck the function with the

servo card switch in the remote position. If they are intact, proceed to START 4.

**START 4 - CHECK ACTUATOR AND LINKAGE.**

**STEP 5G - ARE THEY FUNCTIONAL?** Is the actuator functional and is the linkage intact? If yes, proceed to START 2. If not, replace or repair the necessary part, adjust the servo card, and recheck the function with the servo card switch in the remote position.

**STEP 6 - DOES IT OPERATE PROPERLY?** Does the function operate properly when the thumbwheel on the servo card is rotated? If yes, set the switch on the servo card to the remote position, recheck the function, and proceed to STEP 7. If not, substitute a known good servo card, (See: Servo Card Adjustment Procedure), and check the function by moving the thumbwheel. Proceed to STEP 6A.

**STEP 6A - DOES IT OPERATE PROPERLY?** Does the function operate properly with a new servo card? If yes, adjust the servo card and recheck the function with the switch in the remote position. If not, check the feedback pot and its wires and proceed to STEP 6B.

**STEP 6B - ARE THEY FUNCTIONAL?** Are the wires for that functions feedback pot intact and does the pot function? If not, replace the appropriate part and recheck the function with the servo card switch in the remote position. If yes, check the servo valve and its wires and air lines and proceed to STEP 6C.

**STEP 6C - ARE THEY FUNCTIONAL?** Are the servo valve and its wires and air lines functional? If yes, proceed to START 2. If not, replace the appropriate part, recheck the function with the servo card switch in the local position, and proceed to STEP 6D.

**STEP 6D - DOES IT OPERATE PROPERLY?** Does the function operate properly after the servo valve, wires,

or air lines are replaced? If not, proceed to START 4. If yes, adjust the servo card, recheck the function with the switch in the remote position, and proceed to STEP 6E.

**STEP 6E - DOES IT OPERATE PROPERLY?** Does the function operate properly with the servo card switch in the remote position? If not, proceed to START 2.

**STEP 7 - DOES IT OPERATE?** Does the function operate with the servo card switch in the remote position? If not, substitute a known good servo card, (See: Servo Card Adjustment Procedure), check the function by rotating the thumbwheel, and proceed to STEP 8.

**STEP 8 - DOES IT OPERATE?** Does the function operate with a new servo card? If not, proceed to START 2. If yes, adjust the servo card, recheck the function with the switch in the remote position, and proceed to STEP 9.

**STEP 9 - DOES IT OPERATE PROPERLY?** Does the function operate properly with the servo card switch in the remote position? If not, proceed to START 2.

**START 2 - CHECK COMPUTER SUPPLY AND COMMAND VOLTAGE.**

**STEP 10 - IS THERE SUPPLY AND COMMAND VOLTAGE?**  
Is there voltage to the computer I/O panel and command voltage to the Elco connector pin pair for that function? Check the voltage from the power supply to the I/O panel by making sure the LED's on the front of the panel are lit. If the LED's are not lit, remove the two screws securing the I/O panel and carefully turn it upward. Connect a voltmeter to the single Molex connector on the back of the panel and check the LED's in turn for +5, +12, +24 VDC. If there is no supply voltage, call the Customer Service manager at AVG Productions, Inc. Check the command voltage from the I/O panel by connecting a voltmeter to the Elco pin pair for the function, running a show program,

and monitoring the voltmeter for a 0-10 voltage command variance. If there is command voltage, check the computer data control cable to the figure and proceed to STEP 11. If there is no command voltage, check the MJE 521 transistor and the D to A converter on the I/O panel and proceed to STEP 13.

**STEP 11 - IS IT FUNCTIONAL?** Does the data control cable for the figure have continuity? If yes, call the Customer Service Manager at AVG Productions, Inc. If not, repair or replace necessary part, recheck the function with the servo card switch in the remote position, and proceed to STEP 12.

**STEP 12 - DOES IT FUNCTION?** Does the function operate properly? If not, call the Customer Service Manager at AVG Productions, Inc.

**STEP 13 - IS THERE OUTPUT?** Is there output voltage from the MJE 521 transistor and the D to A converter on the I/O panel? If there is, call the Customer Service Manager at AVG Productions, Inc. If there isn't, replace the appropriate part, recheck the function with the servo card switch in the remote position, and proceed to STEP 14.

**STEP 14 - DOES IT OPERATE PROPERLY?** Does the function operate properly? If not, call the Customer Service Manager at AVG Productions, Inc.

**CHECK COMPLETE**



NO. 18  
PINS 1-18  
TOPSIDE

COMPUTER COMMAND  
POSITIVE INPUT  
(INPUT) GROUND

LO POSITION POT

HI POSITION POT

GROUND PINS 2 AND B

POS. INPUT NO. 1  
PINS 1 AND A

PINS A-V  
UNDERSIDE

VOLTAGE REGULATOR  
WITH HEAT SINK

ADJUSTMENT SCREW

OFFSET POT

STROKE POT

GAIN POT

VELOCITY POT

SELECTOR SWITCH

THUMB WHEEL  
POTENTIOMETER

CLOCKWISE

LOC.  
REM.

SERVO CARD

#### IV - Servo Card Replacement & Calibration

Whenever any servo card is replaced, it must be calibrated to the figure or function it is controlling. The following procedure will explain the proper steps necessary for correct service.

- (1) Carefully remove damaged card from connector, noting position of components.
- (2) Plug in AVG card extension cable and connect card to remote end in proper orientation.

**WARNING: FUNCTION MAY OSCILLATE AT HIGH SPEED WHEN NEW CARD IS INSERTED. BE SURE MAIN SELECTOR SWITCH IS IN LOCAL POSITION.**

- (3) Move pot thumb wheel to one side until oscillation stops.

**A. ADJUSTMENT PROCEDURE:** (refer to servo card illustration).

**NOTE: THE FOLLOWING ADJUSTMENTS REFER TO ACCOMPANYING ILLUSTRATION.**

- velocity* >
- (1) Locate the gain potentiometer and with small screw driver adjust screw clockwise until it clicks. This may require up to 20 turns. *BACK OFF 2 turns*
  - (2) Locate stroke pot and adjust clockwise 20 turns or until click is heard.
  - (3) Locate offset pot and adjust counterclockwise until click is heard.
  - (4) Locate the high feedback pot and adjust clockwise until it clicks.
  - (5) Locate the low feedback pot and turn counterclockwise until it clicks.
  - (6) Move manual thumb wheel pot fully clockwise until it stops.

**NOTE: TOO MUCH COUNTERCLOCKWISE ADJUSTMENT ON VELOCITY POT WILL CAUSE FUNCTION TO OPERATE VERY SLOWLY, IT MAY REQUIRE ADDITIONAL ADJUSTMENT AT THE END OF THIS PROCEDURE.**

- POSITION*
- (7) With thumb wheel pot fully clockwise adjust high feedback pot counterclockwise until function stops. Now adjust clockwise slightly

until function backs off stop the required amount.

- (8) Move thumb wheel counterclockwise. Function should move to opposite direction. Adjust low feedback pot clockwise until function hits mechanical stop at other end of travel from STEP 7. After it stops, return low feedback pot to back off function slightly from stop.
- (9) Check full range of function with thumb wheel pot.
- (10) If function is too fast with tendency to oscillate, move velocity pot counterclockwise until speed is satisfactory. Repeat STEP 7 & 8.
- (11) If speed of function is too low turn velocity pot slowly clockwise until desired speed is achieved. Repeat STEPS 7 & 8.

## V - Servo Valve Trouble Shooting

- A. **CONTAMINATION CHECK** - Disconnect air lines from the valve to the actuator. Mark air lines for refitting later. With air lines disconnected, place function actuator in the middle of its travel range. Place selector switch on servo card in the local position. Activate thumb wheel pot clockwise and counterclockwise. Air should be exhausted from each port separately corresponding to position of thumb wheel. The amount of air coming from each port usually is equal in pressure and volume. If volume and pressure are not equal from one port to the other port the valve is very likely contaminated.

(NOTE:  
SERVO CARD  
SWITCH IN LOCAL  
POSITION WILL  
DISABLE COMPA  
CONTROL

- B. **DECONTAMINATION PROCEDURE** - In order to decontaminate valve, move the pot back and forth rapidly to cycle the valve and expel any contamination until equal amount of air is expelled from each port.

**NOTE:** THIS PROCEDURE MAY REQUIRE SEVERAL MINUTES OR MORE CONTINUOUS CYCLING TO CLEAR CONDITION.

**WARNING:** FAILURE TO RECONNECT THE AIR LINES IN THE CORRECT POSITIONS WILL RESULT IN INOPERATIVE FUNCTION.

- C. **AIR CONTAMINATION** - If valve problem continues to reappear the air system is contaminated. Check filter and entire air system for contamination problems.

- D. **ACTUATOR** - If valve is good when checked out using the previous procedure, the problem may lie in the actuator. Seal failure in actuator will prevent function from operating. If seal is defective replace the actuator, and RETURN TO AVG. FOR CREDIT

## VI - REPAIR AND REPLACEMENT OF STANDARD EYE ASSEMBLY

A full function eye mechanism consists of eyes right/left, up/down, eye blink and eyebrows. The eye right/left function is directly driven by a dual digital actuator while the eye up/down function is driven by a bellcrank with a dual digital actuator. When there is no eye up/down function the actuator is replaced by a solid connecting rod. Eye blink is driven directly by the actuator and the eyebrows are driven by a bellcrank.

**NOTE:** LOCTITE MUST BE ADDED TO ANY NUT OR SCREW IF LOOSENED OR REMOVED!!

(1) **Removal Of Eyes From Head** - Most repairs *Should* and adjustments could be done without having to remove eyes. If removal is necessary, it is done by removing the four mounting screws located on both sides of baseplate (A) (drawing 131904 03 2001). If the figure has eyebrows they must be removed. To remove eyebrows from front of face loosen set screws on eyebrows. To remove eyebrow rod (7) (drawing 131704 03 2011) by loosening clamp screw on (3) , (5) (drawing 131704 03 2011). Eyes should now remove from head.

(2) **Removing Eyelids** - Remove screws (E) , (F) (131904 03 2001) loosen left eyelid bracket (D) (131904 03 2001) noting distance from right eye. Replace eye at same distance.

(3) **Replacing Eyes** - If mechanism has eyelids it must be removed (see step 2). Loosen jam nut (18) (131904 03 2001) from eyeball noting distance from inside of eye to center of pivot ball (7) (131904 03 2001). Unscrew eye and replace at same distance from center of pivot ball.

(4) **Adjusting Eyes For Proper ALIGNMENT** - If eyes are not aligned, center right eye. This is done by centering both dual digital actuators. Center on a dual digital is one shaft in, one shaft out. Adjust

left eye by loosening swivel (9) (131904 03 2001) and sliding to match right eye. When tightening make sure rod (M) (131904 03 2001) is parallel to baseplate (A) (131904 03 2001).

(5) Replacing Eyes Left/Right Actuator - Remove clamp (19) (131904 03 2001) from (M) (131904 03 2001) and actuator left/right mount (6) (131904 03 2001) from baseplate, noting position of part. Unscrew (6) (131904 03 2001) and (3) (131904 03 2001) from other end. When replacing (3) (131904 03 2001) parts (17), (4) (5) (131904 03 2001) should be in the same order as when removed. Tighten (3) (131904 03 2001) so that (5) (131904 03 2001) still slides freely between (4) (131904 03 2001). Attach (6) (131904 03 2001) to baseplate and tighten clamp (19) (131904 03 2001).

(6) Replacing Eye Up/Down Actuator - Check and note height of bellcrank (13) (131904 03 2001) from baseplate. Remove screw from rod end (S) (131904 03 2001) and loosen nut (25) (131904 03 2001) from actuator. Unscrew actuator from rod (N) (131904 03 2001). Screw rod end into new actuator to the same length. After replacing actuator check and adjust bellcrank to same height as before. If out of adjustment it may be adjusted two ways a. Lengthen or shorten rod end from actuator. b. Sliding clevis (15) (131904 03 2001) by loosening screws. Eyes should be in center of eye socket when actuator is in center position.

(7) Replacing Eye Blink Actuator - Remove screw from bracket (K) (131904 03 2001), note length of rod end (R) (131904 03 2001) from end of actuator. Loosen nut (Q) (131904 03 2001) unscrew actuator from rod ends. Reverse steps to replace actuator.

(8) Adjusting Eyebrows - Attach eyebrow to rod (7) (131704 03 2011). Slide rod (7) (131704 03 2011) in until there is minimum clearance between eyebrow and forehead of figure. Tighten driver links (3), (5)

(131704 03 2011) against (2) , (4) (131704 03 2011)  
and clamp (9) (131704 03 2011) against (2) , (4) (131704  
03 2011).

(9) Periodically check all screws, snap rings  
and actuators.

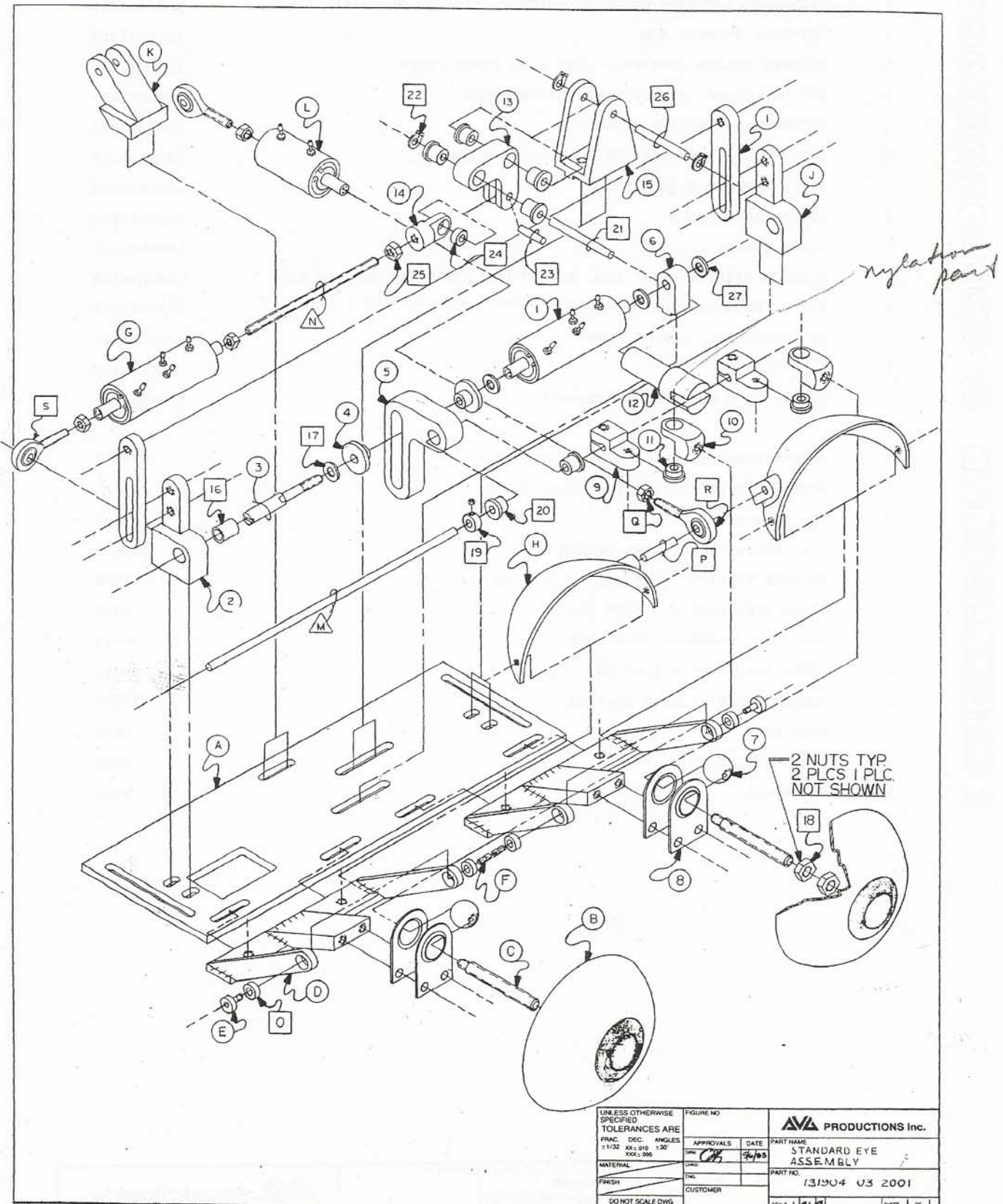



NO.	QTY.	DESCRIPTION	PART #
1	1	ACTUATOR, 1/2" BORE X 1/2" STROKE DUAL DIGITAL LINEAR	1906069570
2	1	UNIVERSAL ACTUATOR MOUNTING BRACKET, EYEBROW MECHANISM STAND	1900041313
3	1	ACTUATOR SUPPORT ROD	1900041300
4	2	FLANGED DELRON BUSHING - .140 I.D. RIGHT./LEFT.	1900041620
5	1	90° BELLCRANK, EYE UP/DOWN - RIGHT/LEFT	1900041628
6	1	ACTUATOR RIGHT/LEFT MOUNT	1900041310
7	2	PIVOT BALL, UNIVERSAL UP/DOWN - RIGHT/LEFT	1900042514
8	4	PIVOT BALL HOUSING	1900042515
9	2	LOWER SWIVEL HALF	1900041626
10	2	UPPER SWIVEL HALF	1900041627
11	2	FLANGED BEARING, 1/8" I.D. X 1/4" LG. (MODIFIED TO 3/16 LG.)	1900044110
12	1	EYE UP/DOWN LIMIT PIN (MADE FROM NYLATRON)	1900041632
13	1	90° BELLCRANK, EYE UP/DOWN	1900041630
14	1	MALE CLEVIS	1900041638
15	1	CLEVIS, EYE UP/DOWN (UNIVERSAL)	1900041629
16	1	SLEEVE BEARING, 3/16" I.D. X 3/8" LG.	047350
17	1	WASHERS, 5/32" I.D. X 3/8" O.D. X .03	047510
18	4	10-32 NUTS	0616
19	1	1/8" PLATED BRASS DURA-COLLAR	047410
20	6	FLANGED BEARING, 1/8" I.D. X 1/8" LG.	044302
21	1	DOWEL PIN, 1/8" x 1 1/2" LG.	2026
22	3	1/8" I.D. EXTERNAL SNAP RING	047210
23	1	DOWEL PIN, 1/8" X 3/8" LG.	2015
24	1	BEARING, 1/8" I.D. X 1/8" LG.	044030
25	2	6-32 NUTS	0610
26	1	DOWEL PIN, 1/8" X 1" LG.	2020
27	3	#6 WASHER	0532

0384

4-23

UNLESS OTHERWISE SPECIFIED TOLERANCES ARE FRAC. DEC. ANGLES = 1/32 XX = .010 = 30° XXX = .005	FIGURE NO.	
	APPROVALS	
MATERIAL	CHKD.	STANDARD EYE ASSEMBLY
FINISH	ENG.	
DO NOT SCALE DWG.	CUSTOMER	PART NO. 131904 03 2001
SCALE		SHEET 2 OF 2

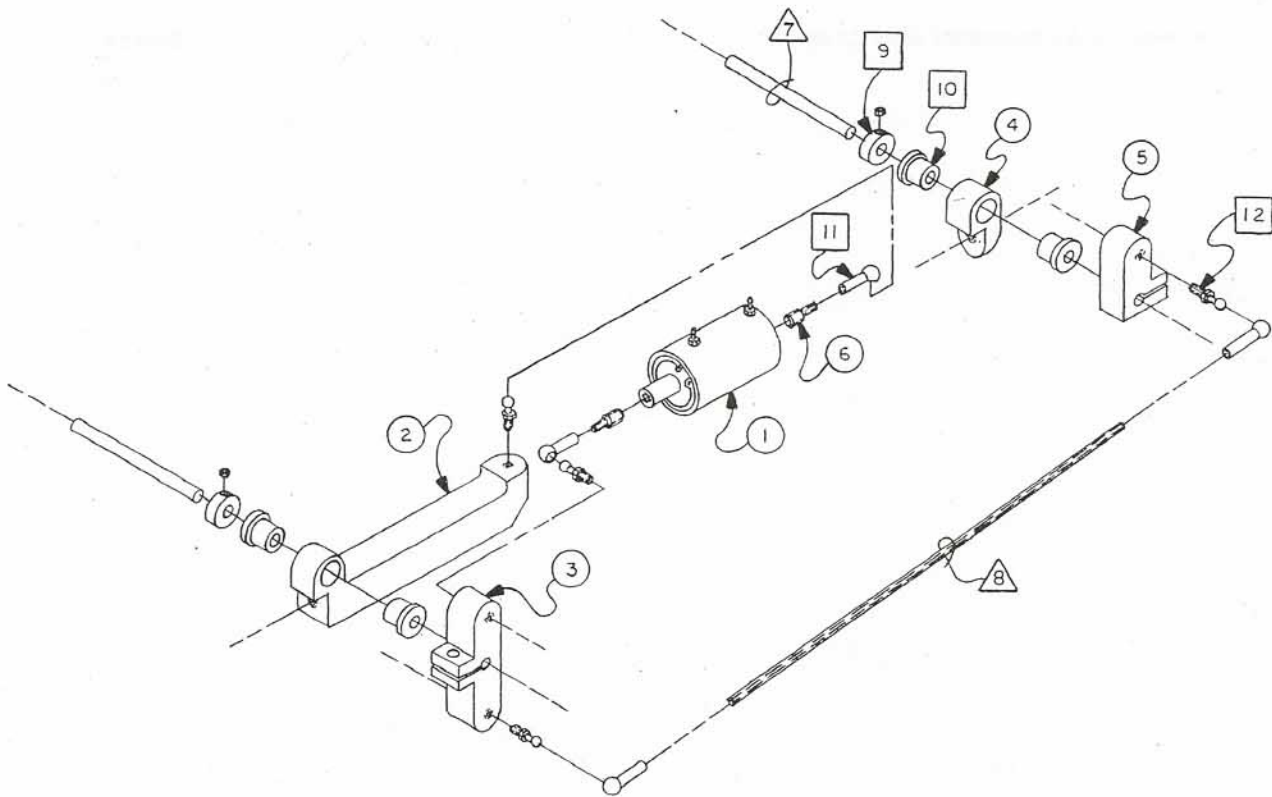

1. REVERSE CONFIGURATION FOR (DUDLEY'S EYE ASSEMBLY) AVK-695.

NOTE:

4-24

UNLESS OTHERWISE SPECIFIED TOLERANCES ARE FRAC. DEC. ANGLES = 1/32 .010 = 30' XXX.XXXX	FIGURE NO.		
	APPROVALS	DATE	
MATERIAL	CHD	5/2/83	STANDARD EYEBROW ASSEMBLY
FINISH	ENG.		PART NO.
DO NOT SCALE DWG.	CUSTOMER		131704 03 2011
	BULLHORN	SCALE	None
			SHEET 1 OF 2

NO.	QTY.	DESCRIPTION	PART #
①	1	ACTUATOR, 1/2" BORE X 1/4" STROKE SINGLE DIGITAL LINEAR	1906069170
②	1	UNIVERSAL EYEBROW MOUNTING BRACKET	1900041312
③	1	EYEBROW DRIVER LINK	1900042216
④	1	EYEBROW ROD MOUNTING PILLOW BLOCK	1900041346
⑤	1	EYEBROW DRIVER - 2nd LINK	1900042218
⑥	2	6-32 TO 2-56 M-M REDUCER	1900044010
△7	1	1/8" DIA. ROD	1900044050
△8	1	4-40 THREADED ROD	2125
□9	2	1/8" PLATED BRASS DURA-COLLARS	047410
□10	4	1/8" I.D. FLANGED BEARING	047315
□11	4 sets	2-56 THREADED BALL LINK	047420
□12			

0384

4-25

UNLESS OTHERWISE SPECIFIED TOLERANCES ARE FRAC. DEC. ANGLES = 1/32 XX = .010 = 30° XXX = .005	FIGURE NO.		
	APPROVALS	DATE	
MATERIAL	DRW	2-24-04	STANDARD EYEBROW ASSEMBLY
FINISH	CHKD.		PART NO.
DO NOT SCALE DWG.	ENG.		131904 03 2011
	CUSTOMER		SCALE
			SHEET 2 OF 2

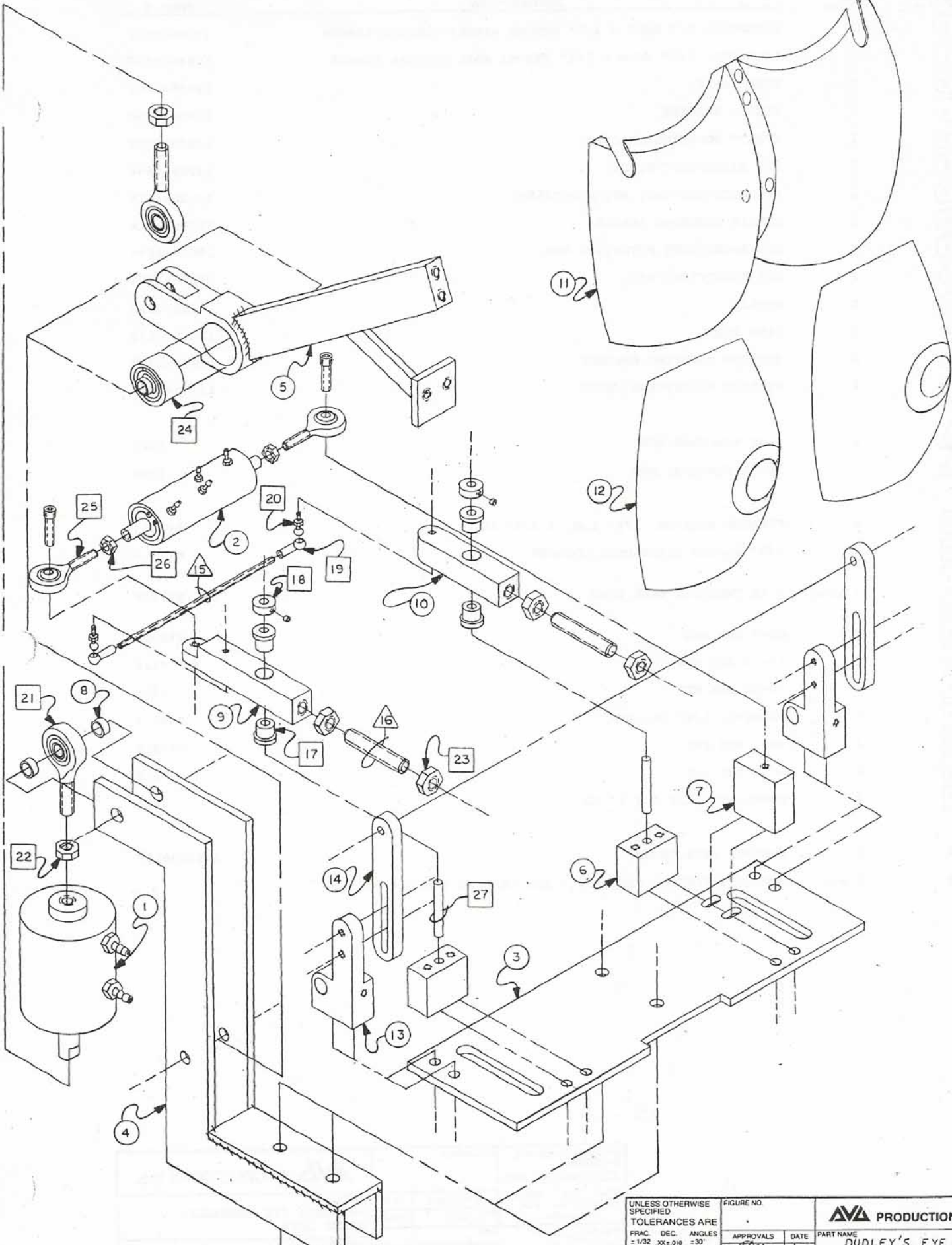

0384

4-26

UNLESS OTHERWISE SPECIFIED TOLERANCES ARE		FIGURE NO.		AVA PRODUCTIONS inc.	
FRAC.	DEC.	ANGLES	APPROVALS	DATE	PART NAME
= 1/32	XX ± .010	= 30°	<i>CAH</i>	4/28/03	DUDLEY'S EYE ASSEMBLY
MATERIAL			ENG	CUSTOMER	PART NO.
FINISH			DO NOT SCALE DWG.	BILLWIKLE	131704 03 2005
				SCALE	SHEET 1 OF 2

NO.	QTY.	DESCRIPTION	PART #
1	1	ACTUATOR, 1 " BORE X 1/2" STROKE SINGLE DIGITAL LINEAR	1906069212
2	1	ACTUATOR, 1/2" BORE X 1/2" STROKE DUAL DIGITAL LINEAR	1906069570
3	1	BASE PLATE	1900041012
4	1	EYELID BRACKET	1900041340
5	1	EYELID MOUNTING BRACKET	1900041338
6	2	EYE RIGHT/LEFT PIVOT	1900041648
7	1	ACTUATOR SUPPORT, EYE RIGHT/LEFT	1900041618
8	2	EYELID ACTUATOR SPACER	1900041914
9	1	EYE RIGHT/LEFT ACTUATING ARM	1900041646
10	1	EYE RIGHT/LEFT B/C	1900041650
11	2	EYELID	1701030130
12	2	DISH EYE	1701030130
13	2	EYEBROW MOUNTING BRACKET	1900041348
14	2	EYEBROW ADJUSTMENT STAND	1900042210
15	1	4-40 THREADED ROD	2125
16	2	10-32 THREADED ROD	2160
17	4	FLANGED BEARING, 1/8" I.D. X 1/4" LG.	047354
18	2	1/8" PLATED BRASS DURA-COLLARS	047410
19	2 sets	2-56 THREADED BALL LINK	047420
20			
21	2	HM-3 ROD END	044012
22	2	10-32 HEX NUT	0616
23	4	10-32 HEX NUT	0616
24	1	BEARING, 1/4" DB. ROW	044424
25	2	HM-2 ROD END	044010
26	2	6-32 HEX NUT	0610
27	2	DOWEL PIN, 1/8 " X 1" LG.	2020
28	2	EYEBROW (NOT SHOWN)	1701030132
29	1 set	STANDARD EYEBROW ASSEMBLY - SEE DRAWING #131904 03 2011	

0384

4-27

UNLESS OTHERWISE SPECIFIED TOLERANCES ARE FRAC. DEC. ANGLES = 1/32 .XX ± .010 ± 30° XXX ± .005	FIGURE NO.		<b>AVA PRODUCTIONS inc.</b>
	APPROVALS	DATE	
MATERIAL	CHKD	2 3 64	PART NAME DUDLEY'S EYE ASSEMBLY PARTS LIST
FINISH	ENG.		PART NO. 131704 03 2005
DO NOT SCALE DWG.	CUSTOMER BULLWINKLE'S		SCALE _____ SHEET 2 OF 2

LTR.	QTY.	DESCRIPTION	PART #
(A)	1	BASE PLATE	1900041016
(B)	2	2 1/2" DIA. EYEBALL	1900030202
(C)	2	PIVOT SHAFT	1900042510
(D)	2	2 1/2" DIA. EYEBALL BRACKET	1900041329
(E)		N/A	
(F)		N/A	
(G)		N/A	
(H)		N/A	
(I)		N/A	
(J)		N/A	
(K)		N/A	
(L)		N/A	
(M)	1	1/8" DIA. ROD (MODIFIED STOCK)	1900044050
(N)	1	6-32 THREADED ROD (WITH 1/4" TUBING SLEEVE)	2134
(O)		N/A	
(P)		N/A	
(Q)	2	6-32 HEX NUT	0610
(R)		N/A	
(S)	1	HF-2 ROD END	044011
T	1 set	STANDARD EYE PARTS - SEE DRAWING #131904 03 2001	

0384

4-28

UNLESS OTHERWISE SPECIFIED, TOLERANCES ARE		FIGURE NO.		
FRAC.	DEC.	ANGLES	APPROVALS	
= 1/32	XX ± .010	= 30°	DRW. 1-10-24	2-8-24
	XXX ± .005		CHKD	
MATERIAL		ENG		PART NAME
FINISH		CUSTOMER		HOPPITY'S EYE ASSEMBLY PARTS LIST
DO NOT SCALE DWG.			BULLWINKLE'S	PART NO. 131704 J3 2009
			SCALE	SHEET 1 of 1

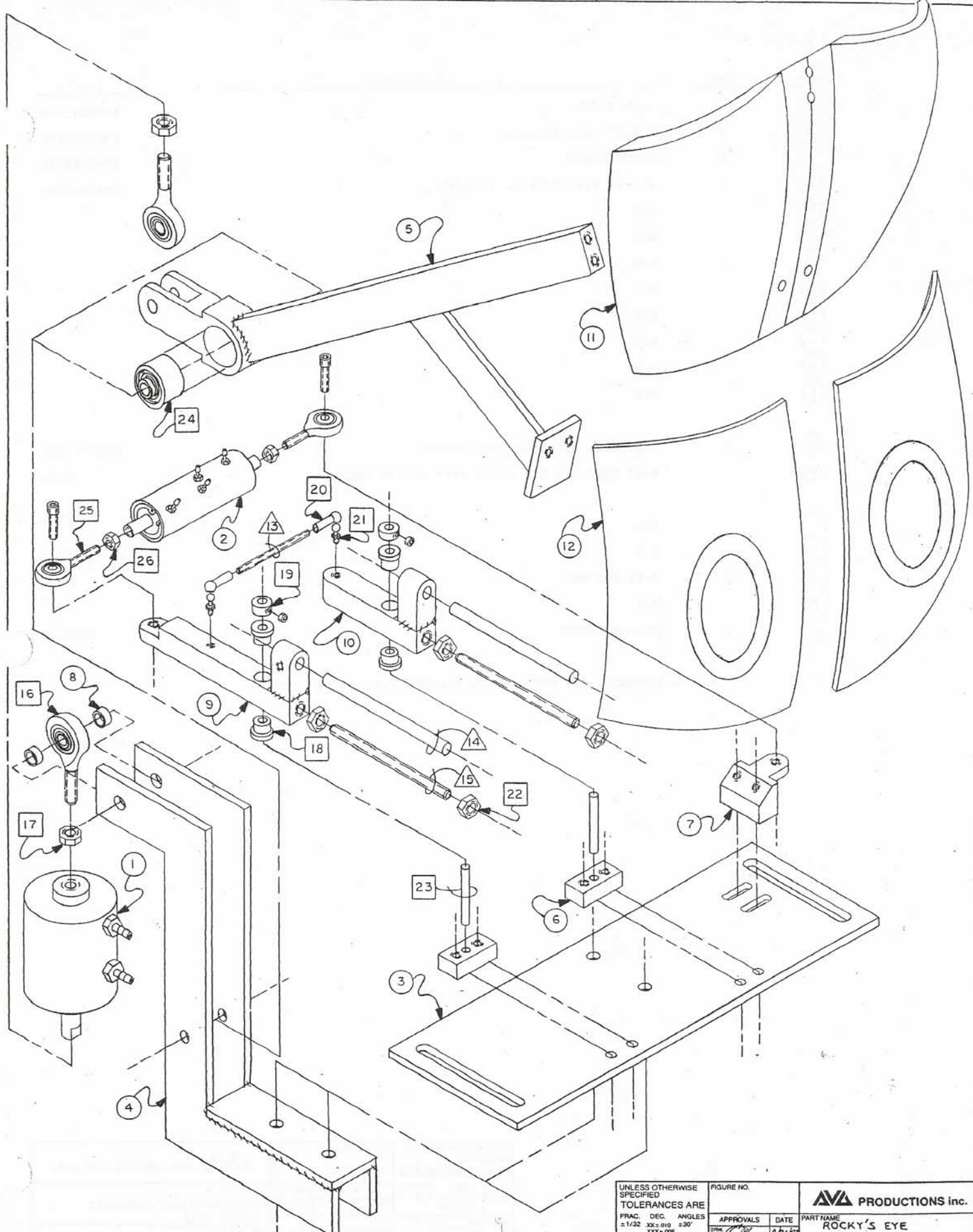

0384

4-29

UNLESS OTHERWISE SPECIFIED TOLERANCES ARE FRAC. DEC. ANGLES $\pm 1/32$ $\pm .010$ $\pm 30^\circ$ $\pm .005$	FIGURE NO.	<b>AVA PRODUCTIONS inc.</b> PART NAME <b>ROCKY'S EYE ASSEMBLY</b>	
	APPROVALS		DATE
	MATERIAL	DRW. <i>[Signature]</i> 4/24/83	PART NO.
	FINISH	ENG. CUSTOMER <b>BULLHUNKLE</b>	131704 03 2006 SCALE: <i>[Signature]</i>
DO NOT SCALE DWG.		SHEET 1 OF 2	

NO.	QTY.	DESCRIPTION	PART #
①	1	ACTUATOR, 1" BORE X 1/2" STROKE SINGLE DIGITAL LINEAR	1906069212
②	1	ACTUATOR, 1/2 " BORE X 1" STROKE DUAL DIGITAL LINEAR	1906069572
③	1	BASE PLATE	1900041014
④	1	EYE LID BRACKET	1900041340
⑤	1	EYE LID MOUNTING BRACKET	1900041326
⑥	2	EYE PIVOT	1900041610
⑦	1	ACTUATOR SUPPORT, EYE RIGHT/LEFT	1900041616
⑧	2	EYELID ACTUATOR SPACER	1900041914
⑨	1	EYE RIGHT/LEFT ACTUATING ARM	1900041612
⑩	1	EYE RIGHT/LEFT B/C	1900041622
⑪	2	EYELID	1703030039
⑫	2	DISH EYE	1703030038
△13	1	4-40 THREADED ROD	2125
△14	2	3/16" DIA. ROD	101410
△15	2	10-32 THREADED ROD	2160
□16	2	HM-3 ROD END	044012
□17	2	10-32 HEX NUT	0616
□18	2	FLANGED BEARING, 1/8" I.D. X 1/4" LG.	047354
□19	2	1/8" PLATED BRASS DURA-COLLARS	047410
□20	2 sets	2-56 THREADED BALL LINK	047420
□21			
□22	4	10-32 HEX NUT	0616
□23	2	DOWEL PIN, 1/8" X 1" LG.	2020
□24	1	BEARING, 1/4" DB. ROW	044424
□25	2	HM-2 ROD END	044010
□26	2	6-32 HEX NUT	0610
□27	2	5-40 SOCKET HEAD CAP SCREW	0023

0384

4-30

UNLESS OTHERWISE SPECIFIED TOLERANCES ARE FRAC. DEC. ANGLES = 1/32 XX = .010 = 30' XXX = .005	FIGURE NO.		<b>AVA</b> PRODUCTIONS inc.
	APPROVALS	DATE	
MATERIAL	DRW	2 S++	PART NO.
FINISH	CHKD		131704 03 2006
DO NOT SCALE DWG.	CUSTOMER	DULLWINKLE'S	SCALE
			SHEET 2 OF 2



LTR.	QTY.	DESCRIPTION	PART #
A	1	BASE PLATE	1900041018
B	2	2 1/2" DIA. EYEBALL	1900030200
C	2	PIVOT SHAFT	1900042510
D	2	2 1/2" DIA. EYEBALL AND EYELID BRACKET	1900041332
E	2	4-40 X 3/16" LG. SHOULDER SCREW (MODIFIED)	1900044031
F	2	4-40 X 1/8" LG. SHOULDER SCREW (MODIFIED)	1900044030
G		N/A	
H	2	EYELID	1900030225
I		N/A	
J		N/A	
K	1	EYELID MOVEMENT BRACKET	1900041342
L	1	ACTUATOR, 1/2" BORE X 1/2" STROKE SINGLE DIGITAL LINEAR	1906069172
M	1	1/8" DIA. ROD (MODIFIED STOCK)	1900044050
N	1	6-32 THREADED ROD (WITH 1/4" TUBING SLEEVE)	2134
O	4	BEARING, 1/8" I.D. X 1/8" LG.	044030
P	1	DOWEL PIN, 1/8" X 3/4" LG.	2018
Q	4	6-32 HEX NUTS	0610
R	2	HM-2 ROD END	044010
S	1	HF-2 ROD END	044011
T	1 set	STANDARD EYE PARTS - SEE DRAWING #13904 03 2001	

0384

4-31

UNLESS OTHERWISE SPECIFIED TOLERANCES ARE FRAC. DEC. ANGLES = 1/32 .XX ± .010 ± 30° XXX ± .005	FIGURE NO.		
	APPROVALS	DATE	
MATERIAL	DRW <i>his</i>	2.6.64	TOOTER'S EYE ASSEMBLY PARTS LIST
FINISH	CHKD.		PART NO.
DO NOT SCALE DWG.	ENG.		131704 03 2007
	CUSTOMER		
	BULLWINKIE'S	SCALE	SHEET 1 OF 1

LTR.	QTY.	DESCRIPTION	PART #
(A)	1	BASE PLATE	1900041018
(B)	2	3 1/4" DIA. EYEBALL	1900030300
(C)	2	PIVOT SHAFT	1900042512
(D)	2	3 1/4" DIA. EYEBALL AND EYELID BRACKET	1900041330
(E)	2	4-40 X 3/16" LG. SHOULDER SCREW (MODIFIED)	1900044031
(F)	2	4-40 X 1/8" LG. SHOULDER SCREW (MODIFIED)	1900044030
(G)	1	ACTUATOR, 1/2" BORE X 1/2" STROKE DUAL DIGITAL, LINEAR	1906069170
(H)	2	EYELID	1900030325
(I)	2	EYEBROW ADJUSTMENT STAND	1900042210
(J)	1	EYEBROW MOUNTING BRACKET	1900041348
(K)	1	EYELID MOVEMENT BRACKET	1900041342
(L)	1	ACTUATOR, 1/2" BORE X 3/4" STROKE SINGLE DIGITAL LINEAR	1906069174
(M)	1	1/8" DIA. ROD (MODIFIED STOCK)	1900044050
(N)	1	6-32 THREADED ROD	2134
(O)	4	BEARING, 1/8" I.D. X 1/8" LG.	044030
(P)	1	DOWEL PIN, 1/8" X 3/4" LG.	2018
(Q)	5	6-32 HEX NUT	0610
(R)	2	HM-2 ROD END	044010
(S)	1	HM-2 ROD END	044010
T	2	EYEBROW (NOT SHOWN)	1705030014
U	1 set	STANDARD EYE PARTS - SEE DRAWING #131904 03 2001	
V	1 set	STANDARD EYEBROW PARTS - SEE DRAWING #131904 03 2011	

0384

4-32

UNLESS OTHERWISE SPECIFIED TOLERANCES ARE		FIGURE NO.		
FRAC.	DEC.	ANGLES	APPROVALS	
= 1/32	XX = .010	= 30°	DRW	2-8-80
	XXX = .005		CHKD	
MATERIAL			ENG.	PART NAME
FINISH			CUSTOMER	BULLWINKLE'S EYE ASSEMBLY
DO NOT SCALE DWG.	BULLWINKLE'S		SCALE	PARTS LIST
				PART NO. 131704 03 2002
				SHEET 1 OF 1

LTR.	QTY.	DESCRIPTION	PART #
(A)	1	BASE PLATE	1900041018
(B)	2	3 1/4" DIA. EYEBALL	1900030301
(C)	2	PIVOT SHAFT	1900042512
(D)	2	3 1/4" DIA EYEBALL AND EYELID BRACKET	1900041334
(E)	2	4-40 X 3/16" LG. SHOULDER SCREW (MODIFIED)	1900044031
(F)	2	4-40 X 1/8" LG. SHOULDER SCREW (MODIFIED)	1900044030
(G)	1	ACTUATOR, 1/2" BORE X 3/4" STROKE SINGLE DIGITAL LINEAR	1906069174
(H)	2	EYELID	1900030325
(I)	2	EYEBROW ADJUSTMENT STAND	1900042212
(J)	1	UNIVERSAL ACTUATOR MOUNTING BRACKET/EYEBROW MECHANISM STAND	1900041348
(K)	1	EYELID ACTUATOR CLEVIS WITH STANDOFF	1900041905
(L)	1	ACTUATOR, 1/2" BORE X 1/2" STROKE DUAL DIGITAL LINEAR	1906069570
(M)	1	1/8" DIA. ROD (MODIFIED STOCK)	1900044050
(N)	1	6-32 THREADED ROD	2134
(O)	4	BEARING, 1/8" I.D. X 1/8" LG.	044030
(P)	1	DOWEL PIN, 1/8" X 3/4" LG.	2018
(Q)	5	6-32 HEX NUT	0610
(R)	2	HM-2 ROD END	044010
(S)	1	HM-2 ROD END	044010
T	2	EYEBROW (NOT SHOWN)	1706030069
U	1 set	STANDARD EYE PARTS - SEE DRAWING #131904 03 2001	
V	1 set	STANDARD EYEBROW PARTS - SEE DRAWING #131904 03 2011	

0384

4-33

UNLESS OTHERWISE SPECIFIED TOLERANCES ARE FRAC. DEC. ANGLES = 1/32 .XX ± .010 = 30' XXX ± .005	FIGURE NO.		<b>AVA PRODUCTIONS inc.</b>
	APPROVALS	DATE	
MATERIAL	CHKD.	2 5 54	UNDERDOG'S EYE ASSEMBLY
FINISH	ENG.		PARTS LIST
DO NOT SCALE DWG.	CUSTOMER		PART NO. 131704 03 2003
	BULLWINKLE'S	SCALE	SHEET 1 OF 1

LTR.	QTY.	DESCRIPTION	PART #
(A)	1	BASE PLATE	1900041016
(B)	2	2 1/2" DIA. EYEBALL	1900030201
(C)	2	PIVOT SHAFT	1900042510
(D)	2	2 1/2" DIA. EYEBALL MOUNTING BRACKET	1900041329
(E)		N/A	
(F)		N/A	
(G)		N/A	
(H)		N/A	
(I)		N/A	
(J)		N/A	
(K)		N/A	
(L)		N/A	
(M)	1	1/8" DIA. ROD (MODIFIED STOCK)	1900044050
(N)	1	6-32 THREADED ROD (WITH 1/4" TUBING SLEEVE)	2134
(O)		N/A	
(P)		N/A	
(Q)	2	6-32 HEX NUT	0610
(R)		N/A	
(S)	1	HF-2 ROD END	044011
T	1 set	STANDARD EYE PARTS - SEE DRAWING #131904 03 2001	

0384

4-34

UNLESS OTHERWISE SPECIFIED TOLERANCES ARE		FIGURE NO.		
FRAC. DEC. ANGLES = 1/32 XX = .010 = 30' XXX = .005		APPROVALS	DATE	
MATERIAL	CHKD.	DRW. <i>for</i>	2-5-04	PART NAME NATASHA'S EYE ASSEMBLY
FINISH	ENGR.	CUSTOMER		PARTS LIST PART NO. 131704 03 2010
DO NOT SCALE DWG.	BULLWINKLE		SCALE	SHEET 1 OF 1

LTR.	QTY.	DESCRIPTION	PART #
(A)	1	BASE PLATE	1900041020
(B)	2	3 1/4" DIA. EYEBALL	1708030211
(C)	2	PIVOT SHAFT	1900042512
(D)	2	3 1/4" DIA. EYEBALL BRACKET	1900041334
(E)		N/A	
(P)		N/A	
(G)		N/A	
(H)		N/A	
(I)		N/A	
(J)		N/A	
(K)		N/A	
(L)		N/A	
(M)	1	1/8" DIA. ROD (MODIFIED STOCK)	1900044050
(N)	1	6-32 THREADED ROD (WITH 1/4" TUBING SLEEVE)	2134
(O)		N/A	
(P)		N/A	
(Q)	2	6-32 HEX NUT	0610
(R)		N/A	
(S)	1	HF-2 ROD END	044011
T	1 set	STANDARD EYE PARTS - SEE DRAWING #131904 03 2001	

0384

4-35

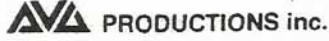
UNLESS OTHERWISE SPECIFIED TOLERANCES ARE		FIGURE NO.			
FRAC. = 1/32	DEC. = .010	ANGLES = 30'	XXX = .005		
MATERIAL		CHKD		PART NAME	
FINISH		ENG		BORIS' EYE ASSEMBLY	
DO NOT SCALE DWG.		CUSTOMER		PARTS LIST	
BULLWINKLE'S		SCALE		PART NO. 131704 03 20008	
				SHEET 1 OF 1	

LTR.	QTY.	DESCRIPTION	PART #
(A)	1	BASE PLATE	1900041016
(B)	2	2 1/2" DIA. EYEBALL	1900030201
(C)	2	PIVOT SHAFT	1900042510
(D)	2	2 1/2" DIA. EYEBALL AND EYELID BRACKET	1900041332
(E)	2	4-40 X 3/16" LG. SHOULDER SCREW (MODIFIED)	1900044031
(F)	2	4-40 X 1/8" LG. SHOULDER SCREW (MODIFIED)	1900044030
(G)		N/A	
(H)	2	EYELID	1900030225
(I)	2	EYEBROW ADJUSTMENT STAND	1900042214
(J)	1	EYEBROW MOUNTING BRACKET	1900041348
(K)	1	EYELID MOVEMENT BRACKET	1900041342
(L)	1	ACTUATOR, 1/2" BORE X 3/4" STROKE SINGLE DIGITAL LINEAR	1906069174
(M)	1	1/8" DIA. ROD (MODIFIED STOCK)	1900044050
(N)	1	6-32 THREADED ROD (WITH 1/4" TUBING SLEEVE)	2134
(O)	4	BEARING, 1/8" I.D. X 1/8" LG.	044030
(P)	1	DOWEL PIN, 1/8" X 3/4" LG.	2018
(Q)	4	6-32 HEX NUT	0610
(R)	2	HM-2 ROD END	044010
(S)	1	HF-2 ROD END	044011
T	2	EYEBROW (NOT SHOWN)	1709030100
U	1 set	STANDARD EYE PARTS - SEE DRAWING #131904 03 2001	
V	1 set	STANDARD EYEBROW PARTS - SEE DRAWING #131904 03 2011	

0384

4-36

UNLESS OTHERWISE SPECIFIED TOLERANCES ARE FRAC. DEC. ANGLES = 1/32 XX = .010 = 30' XXX = .005	FIGURE NO.	<b>AVA PRODUCTIONS inc.</b>		
	APPROVALS		DATE	PART NAME
MATERIAL	CHKD.			SNIDELY'S EYE ASSEMBLY
FINISH	ENG.			PARTS LIST
DO NOT SCALE DWG.	CUSTOMER			PART NO. 131704 03 2004
	BULLWINKLE'S	SCALE		SHEET 1 OF 1

## VII - REPLACING FUNCTIONAL PARTS

A. **ROD ENDS** - Most commonly used for a mechanical movement. The threaded side of the rod end is fastened to one or both ends of a linear actuator and then the spherical end of the rod end is attached to a clevis located on the moving part of the mechanism.

- (1) Remove all parts necessary in order to have an open access to area you need to work on.
- (2) Measure the visible threads to determine how far the rod end is screwed into the actuator.
- (3) Remove rod end from the clevis by removing the bolt and lock nut.
- (4) Loosen jam nut on rod end and remove rod end from the actuator.
- (5) Put jam nut on new rod end, put Loctite on threads and screw into same location as the old one.
- (6) Tighten jam nut while holding actuator so that the air fittings stay in the same location. Be careful not to over tighten and strip threads.

B. **BEARINGS** - Bearings are mostly used for pivot points on a figure. Most bearings are pressed into a housing for support.

- (1) Remove all parts attached to mechanism containing bearing.
- (2) Remove mechanism.
- (3) Press on outer race of bearing for removal.
- (4) Press in new bearing and peen housing so bearing is secure.
- (5) Reassemble mechanism and reattach all parts to original position.

PARTS LIST

I - ANIMATION - EYES

<u>DESCRIPTION</u>	<u>PART NUMBER</u>
Base Plate	1900041012
Base Plate	1900041014
Base Plate	1900041016
Base Plate	1900041018
Actuator Support Rod	1900041300
Actuator Right/Left Mount	1900041310
Universal Actuator Mounting Bracket	1900041313
2 1/2" Dia. Eyeball Bracket	1900041329
3 1/4" Dia. Eyeball and Eyelid Bracket	1900041330
2 1/2" Dia. Eyeball and Eyelid Bracket	1900041332
3 1/4" Dia. Eyeball Bracket	1900041334
Eyelid Mounting Bracket	1900041338
Eyelid Bracket	1900041340
Eyelid Movement Bracket	1900041342
Eyebrow Rod Mounting Pillow Block	1900041346
Eyebrow Mounting Bracket	1900041348
Eye Right/Left Actuating Arm	1900041612
Actuator Support, Eye Right/Left	1900041616
Actuator Support, Eye Right/Left	1900041618
Flanged Delron Brushing - .140 ID.	1900041620
Eye Right/Left Bellcrank	1900041622
Lower Swivel Half	1900041626
Upper Swivel Half	1900041627
90° Bellcrank, Eye Up/Down - Right/Left	1900041628
Clevis, Eye Up/Down (Universal)	1900041629
90° Bellcrank Eye Up/Down	1900041630
Eye Up/Down Limit Pin	1900041632
Male Clevis	1900041638
Eye Right/Left Actuating Arm	1900041646
Eye Right/Left Pivot	1900041648
Eyes Right/Left Bellcrank	1900041650
Eyelid Actuator Clevis with Standoff	1900041905
Eyelid Actuator Spacer	1900041914
Eyebrow Adjustment Stand	1900042210



PARTS LIST

ANIMATION - EYES

Eyebrow Adjustment Stand	1900042212
Eyebrow Adjustment Stand	1900042214
Eyebrow Driver Link	1900042216
Eyebrow Driver - 2nd Link	1900042218
Pivot Shaft	1900042510
Pivot Shaft	1900042512
Pivot Ball, Universal Up/Down - Right/Left	1900042514
Pivot Ball Housing	1900042515
6-32 to 2-56 M-M Reducer	1900044010
4-40 X 1/8" Lg. Shoulder Screw (Mod.)	1900044030
4-40 X 3/16" Lg. Shoulder Screw (Mod.)	1900044031
1/8" Dia. Rod (Modified Stock)	1900044050
Flanged Bearing, 1/8" ID X 1/4" Long	1900044110
HM-2 Rod End	044010
HF-2 Rod End	044011
HM-3 Rod End	044012
Bearing, 1/8" ID X 1/8" Long	044030
Flanged Bearing, 1/8" ID X 1/8" Long	044302
Bearing, 1/4" Double Row	044324
1/8" ID External Snap Ring	047210
Flanged Bearing, 1/8" ID	047315
Sleeve Bearing, 3/16" ID X 3/8" Long	047350
Flanged Bearing, 1/8" ID X 1/4 Long	047354
1/8" Plated brass Dura-Collar	047410
2-56 Threaded Ball Link	047420
Washers, 5/32" ID X 3/8" OD X .03	047510
3/16" Dia. Rod	101410
#6 Washer	0532
6-32 Hex Nuts	0610
10-32 Hex Nuts	0616
Dowel Pin 1/8" Dia. X 3/8" Long	2015
Dowel Pin 1/8" Dia. X 3/4" Long	2018
Dowel Pin 1/8" Dia. X 1" Long	2020
Dowel Pin 1/8" Dia. X 1 1/2" Long	2026
4-40 Threaded Rod	2125
6-32 Threaded Rod	2134
10-32 Threaded Rod	2160

PARTS LIST

ANIMATION - BEARINGS

<u>DESCRIPTION</u>	<u>PART NUMBER</u>
1/8" Male Rod End	044010
3/16" Male Rod End	044012
1/4" Male Rod End	044014
3/8" Male Rod End	044018
1/4" Self-lubricating Male Rod End	044051
3/16" Self-lubricating Male Rod End	044060
3/8" Single Row Shielded Bearing	044340
5/8" Single Row Shielded Bearing	044360
3/16" Double Row Bearing	044410
1/4" Double Row bearing	044420
1/4" Double Row 3/4" O.D. Bearing	044424
5/16" Double Row Bearing	044430
3/4" Pillow Block	044612
3/8" 2 Piece Shaft Collar	046214
5/8" 2 Piece Shaft Collar	046220
1" Universal Joint	046410
1 1/16" Internal Snap Ring	047126

PARTS LIST

II - ELECTRONICS

<u>DESCRIPTION</u>	<u>PART NUMBER</u>
Tascam 133 Cassette Deck	071005
Otari 1/4" Reel To Reel Tape Machine	071010
CPU Push Buttons	073705
C & K 7103 Toggle Switch	073710
1 Amp Micro Fuse	073771
2 Amp Slo-Blo Fuse	073772
6 Amp Slo-Blo Fuse	073776
Rotary Feedback Pot	073800
CPU Power Supply	074005
Dual Mono Audio Amplifier	074010
2N 3904 Semiconductor	077010
2N 3906 Semiconductor	077015
MJE 521 Semiconductor	077110
MJE 800 Semiconductor	077120
Vactrol Opto-Resistor	077570
4N35 Semiconductor	078010
74LS 138N Semiconductor	078015
74LS 00N Semiconductor	078020
Intel 8283 Semiconductor	078025
74LS 240N Semiconductor	078030
XR 2211 Semiconductor	078035
CD 4011 Semiconductor	078040
DM 7438 Semiconductor	078045
LM 556 Semiconductor	078055
LM 324 Semiconductor	078060
AD 558 Semiconductor	078200
Intel 80/24 CPU	078300
Cooling Fan	078400
Servo Card	1900070010
Remote Switch	1900070020
Servo Card Extension	1900070025
<i>Lotney</i> <del>FPS</del> BACK EXTENSION TEST LEAD	1900070030
Digital I/O Panel	1900070032
Analog I/O Panel	

PARTS LIST

**ELECTRONICS - (cont.)**

I/O Chassis/Power Supply Assembly	1900070105
Cross-Connect/Panel Assembly	1900070110
Flat Cable Assembly	1900070150
Control Module	1900070210
Tape Machine/Timer Select Panel	1900070250
AVG Dimmer Interface Unit	1900070260
AVG Single Channel Playback Module	1900070270
Dudley Data Control Cable	1701070120
Hoppity Data Control Cable	1702070150
Rocky Data Control Cable	1703070030
Tooter Data Control Cable	1704070180
Bullwinkle Data Control Cable	1705070001
Underdog Data Control Cable	1706070060
Boris/Natasha Data Control Cable	1708070210
Snidely Data Control Cable	1709070090
Snidely Control System	1709070091
Bullwinkle Show Control System	1710070211
Main Power Panel	1710070212
Curtain Data Control Cable	1710070220
Dimmer Data Control Cable	1710070225
Water Show Data Control Cable	1710070230

PARTS LIST

ELECTRONICS - SOUND & LIGHTING

<u>DESCRIPTION</u>	<u>PART NUMBER</u>
Tannoy Speakers	120010
Continental 802 Speakers	120012
3" Fresnel Light	120110
6" Fresnel Light	120112
3½" Mini Ellipsoidal Spotlight	120120
Multi R-40 Flood Light	120130
150 Q/CL Lamp	120150
120/ER40 Lamp	120155
500 Q/CL Lamp	120160
500 BTL Lamp	120165
3¼" Pink Glass Filter	120210
3¼" Light Lavender Glass Filter	120211
3¼" Dark Lavender Glass Filter	120212
6" Red Glass Filter	120220
QSC 835 Dimmer	120510

PARTS LIST

III - FIGURE - DUDLEY DO-RIGHT

<u>DESCRIPTION</u>	<u>PART NUMBER</u>
Base Frame	1701040120
Torso Frame	1701040121
Upper Jaw Frame	1701040122
Right Leg Armiture	1701040125
Lower Jaw Mechanism	1701040130
Neck Mechanism	1701040134
Upper Left Arm Mechanism	1701040136
Lower Left Arm Mechanism	1701040137
Head	1701030120
Lower Jaw	1701030121
Right Arm & Hand	1701030122
Left Upper Arm	1701030123
Left Lower Arm	1701030124
Right Boot	1701030125
Left Boot	1701030126
Right Leg	1701030127
Torso	1701030128
Torso Back	1701030129
Eyes (Special Blue)	1701030130
Eyelids (Special)	1701030131
Eyebrows	1701030132
Right Hand - Right Knee Ball Joint	1701030133
Picture Frame	1701030134
Box	1701020120
Speaker Window With Scrim	1701020121
Bolt Down Box	1701020122
Jacket	1701010120
Pants	1701010121
Hat	1701010122

PARTS LIST

FIGURE - HOPPITY HOOPER

<u>Description</u>	<u>PART NUMBER</u>
Torso	1702030150
Right Arm	1702030151
Left Arm	1702030152
Right Leg	1702030153
Left Leg	1702030154
Torso Door	1702030155
Harmonica	1702030156
Base Frame	1702040150
Upper Frame Torso, Head, Harmonica Mount	1702040152
Speaker & Pneumatic Box Sub-Frame	1702040154
Harmonica Mechanism Armiture	1702040158
Shirt	1702010150
Pants	1702010151
Boxes (4) with Scrim	1702020150

PARTS LIST

FIGURE - ROCKY

<u>DESCRIPTION</u>	<u>PART NUMBER</u>
Head	1703030030
Skin	1703030031
Body	1703030032
Body Door	1703030033
Teeth	1703030034
Right Arm & Hand	1703030035
Left Arm & Hand	1703030036
Tail	1703030037
Eyes (Sepcial Blue)	1703030038
Eyelids (Special)	1703030039
Fiddle	1703030040
Fiddle Door	1703030041
Bow	1703030042
Fiddle Adjusting Keys	1703030043
Fiddle Twig	1703030044
Base Frame	1703040030
Head Frame	1703040032
Fiddle Frame	1703040034
Left Hand Slide Mechanism	1703040040
Bow Slide Mechanism	1703040042
Right Hand Mechanism	1703040044
Box	1703020030
"Upsa Um" Box	1703020031
Hat	1703010030
Scarf	1703010031
Tail Fur	1703010032



PARTS LIST

FIGURE - TOOTER TURTLE

<u>DESCRIPTION</u>	<u>PART NUMBER</u>
Base Frame Torso, Drums, Rotary Head Mounts	1704040180
Speaker & Pneumatic Box Sub-Frame	1704040182
Head Frame	1704040184
Right Arm Armiture	1704040190
Left Arm Armiture	1704040191
Right Hand Armiture	1704040194
Left Hand Armiture	1704040195
Drum Armiture	1704040196
Cymbal Mount	1704040198
Tambourine Mount	1704040199
Head	1704030180
Lower Jaw	1704030181
Right Arm	1704030182
Left Arm	1704030183
Right Leg	1704030184
Left Leg	1704030185
Torso	1704030186
Torso Door	1704030187
Right Hand	1704030188
Left Hand	1704030189
Drums	1704030190
Drum Sticks	1704030191
Small Drum Ring	1704030192
Large Drum Ring	1704030193
Cymbals	1704030194
Collar & Cuffs	1704010180
Hat	1704010181
Garter	1704010182
Boxes (4) with Scrim	1704020180

PARTS LIST

FIGURE - BULLWINKLE

<u>DESCRIPTION</u>	<u>PART NUMBER</u>
Base Frame	1705040002
Barrel Frame	1705040004
Torso Frame	1705040006
Head Frame	1705040008
Banjo Frame	1705040010
Right Arm Armiture	1705040015
Left Arm Armiture	1705040016
Right Hand Mechanism Armiture	1705040018
Right Leg Armiture	1705040020
Left Leg Armiture	1705040021
Right Foot Mechanism Armiture	1705040022
Snout Mechanism	1705040025
Neck Mechanism	1705040026
Right Hand Strumming Mechanism With One Bellcrank	1705040027
Head	1705030001
Nose Plate	1705030002
Nose	1705030003
Antlers	1705030004
Right Arm & Hand	1705030005
Left Arm	1705030006
Left Hand	1705030007
Right Leg	1705030008
Left Leg	1705030009
Right Foot	1705030010
Left Foot	1705030011
Torso Front	1705030012
Torso Back	1705030013
Eyebrows	1705030014
Banjo	1705030015
Banjo Band	1705030016
Banjo Adjusting Key	1705030017
Barrel	1705030020

PARTS LIST

FIGURE - BULLWINKLE (con't)

<u>DESCRIPTION</u>	<u>PART NUMBER</u>
Coat	1705010001
Pants	1705010002
Dickie	1705010003
Leg Fur	1705010004
Head Fur	1705010005
Neck Fur	1705010006
Bolt Down Box	1705020002

PARTS LIST

FIGURE - UNDERDOG

<u>DESCRIPTION</u>	<u>PART NUMBER</u>
Base Frame	1706040060
Head Frame	1706040062
Saxophone Frame	1706040064
Lower Torso Mechanism Frame	1706040066
Upper Body Mechanism Frame	1706040067
Left Hand Mounting Assembly	1706040070
Snout Mechanism	1706040075
Right Hand Mechanism	1706040078
Head	1706030060
Right Arm & Hand	1706030061
Left Arm & Hand	1706030062
Right Leg	1706030063
Left Leg	1706030064
Nose	1706030065
Nose Base	1706030066
Torso	1706030067
Torso Back	1706030068
Eyebrows	1706030069
Saxophone	1706030070
Barrel	1706030071
Snow Shoes	1706030072
Red Suit	1706010060
Blue Cape	1706010061
Chair	1706020060
Speaker Window with Scrim	1706020061

PARTS LIST

FIGURE - BORIS & NATASHA

<u>DESCRIPTION</u>	<u>PART NUMBER</u>
Heads (Boris & Natasha)	1708030210
Eyes (Special Brown) (Boris)	1708030211
Base Frame (Boris & Natasha)	1707040210
Mouth Mechanism (Boris)	1707040215
Mouth Mechanism (Natasha)	1708040220

PARTS LIST

FIGURE - SNIDELY

<u>DESCRIPTION</u>	<u>PART NUMBER</u>
Torso Frame	1709040090
(2) Bellcranks - Sign, Head Turn	1709040092
Head Frame	1709040094
Teeth Plates	1709040096
Mouth Slide Mechanism	1709040100
Cage Sides (2)	1709040110
Cage Front	1709040112
Cage Window	1709040114
Cage Door	1709040116
Nose	1709030093
Right Arm & Hand	1709030094
Left Arm & Hand	1709030095
Right Leg	1709030096
Left Leg	1709030097
Torso	1709030098
Torso Back	1709030099
Eyebrows	1709030100
Mustache	1709030101
Teeth Plate	1709030102
"Wanted..." Sign	1709030103
Barrel	1709030104
"Home Sweet Home" Frame	1709020090
Speaker Boxes (2) with Scrim	1709020091
Jail Cell Window	1709020092
"Mother" Picture & Frame	1709020093
Chair	1709020094
Head	1709030090
Top Teeth	1709030091
Bottom Teeth	1709030092
Jacket	1709010090
Hat	1709010091

PARTS LIST

IV - PNEUMATICS

<u>DESCRIPTION</u>	<u>PART NUMBER</u>
Compressor	060000
Compressor Shock Mounts	060005
Air Dryer	060008
Air Dryer Stand	1900044500
Coalescent Filter	060010
1/2" Air Filter	060026
Automatic Drain Valve	060040
Air Regulator	060050
1/8" NPT 160 PSI Pressure Gauge	060062
Mag Starter	060080
Nema #2 Heater	060085
Single Stage <sup>4 way?</sup> Servo Valve <del>NO. 00175, T00172</del>	065001
Dual Stage Servo Valve <del>6W, POLY, DUBLEY, UNDELDUB</del>	065002
10-32 UNF 4-Way Solenoid Valve (MAC VALVE)	065053
2" X 53" Linear Actuator <del>CURTAINS, LEFT &amp; RIGHT</del>	069010
2" X 90" Linear Actuator <del>CURTAIN, CENTER</del>	069020

2ndARY  
?  
?

Which valves are FLOW CONTROL?  
BRASS 10-32 UNF

? SERVO VALVE 4WAY PROPORTIONAL, DUAL STAGE 1/8" NPT

PARTS LIST

FIGURE - SNIDELY

<u>DESCRIPTION</u>	<u>PART NUMBER</u>
Torso Frame	1709040090
(2) Bellcranks - Sign, Head Turn	1709040092
Head Frame	1709040094
Teeth Plates	1709040096
Mouth Slide Mechanism	1709040100
Cage Sides (2)	1709040110
Cage Front	1709040112
Cage Window	1709040114
Cage Door	1709040116
Nose	1709030093
Right Arm & Hand	1709030094
Left Arm & Hand	1709030095
Right Leg	1709030096
Left Leg	1709030097
Torso	1709030098
Torso Back	1709030099
Eyebrows	1709030100
Mustache	1709030101
Teeth Plate	1709030102
"Wanted..." Sign	1709030103
Barrel	1709030104
"Home Sweet Home" Frame	1709020090
Speaker Boxes (2) with Scrim	1709020091
Jail Cell Window	1709020092
"Mother" Picture & Frame	1709020093
Chair	1709020094
Head	1709030090
Top Teeth	1709030091
Bottom Teeth	1709030092
Jacket	1709010090
Hat	1709010091



PARTS LIST

IV - PNEUMATICS

<u>DESCRIPTION</u>	<u>PART NUMBER</u>
Compressor	060000
Compressor Shock Mounts	060005
Air Dryer	060008
Air Dryer Stand	1900044500
Coalescent Filter	060010
1/2" Air Filter	060026
Automatic Drain Valve	060040
Air Regulator	060050
1/8" NPT 160 PSI Pressure Gauge	060062
Mag Starter	060080
Nema #2 Heater	060085
Single Stage <sup>4 way?</sup> Servo Valve <sup>NO. 0017, TOTAL</sup>	065001
Dual Stage Servo Valve <sup>BW, POLY, DUBLEY, UNDERDUB</sup>	065002
10-32 UNF 4-Way Solenoid Valve (MAC VALVE)	065053
2" X 53" Linear Actuator <sup>CURTAINS, LEFT &amp; RIGHT</sup>	069010
2" X 90" Linear Actuator <sup>CURTAIN, CENTER</sup>	069020

2nd DAMY  
?  
?

Which valves are FLOW CONTROL?  
BRASS 10-32 UNF

? SERVO VALVE 4 WAY PROPORTIONAL, DUAL STAGE 1/8" NPT

PARTS LIST

PNEUMATICS - ACTUATORS

DESCRIPTION	PART NUMBER
? 1" Bore X 30° Rotary Actuator	1906069010
1 1/2" Bore X 30° Rotary Actuator <i>NOPPIY HOOPER'S BODY</i>	1906069024
1 1/2" Bore X 90° Rotary Actuator <i>TOOTERTUKE'S</i>	1906069027
2" Bore X 45° Rotary Actuator <i>ROCKY'S &amp; UNDERDOGS</i>	1906069031
2" Bore X 60° Rotary Actuator <i>DUDLEY DO-RIGHT'S</i>	1906069032
2 1/2 " Bor X 90° Rotary Actuator <i>BULLWINKLE'S HEAD TURN</i>	1906069043
1/2 " Bore X 1/4" Stroke S.D. Linear Actuator	1906069170
1/2 " Bore X 1/2" Stroke S.D. Linear Actuator	1906069172
1/2" Bore X 3/4" Stroke S.D. Linear Actuator	1906069174
3/4" Bore X 1/4 Stroke S.D. Linear Actuator	1906069190
3/4" Bore X 1" Stroke S.D. Linear Actuator	1906069196
1" Bore X 1/2" Stroke S.D. Linear Actuator	1906069212
1" Bore X 1" Stroke S.D. Linear Actuator	1906069218
1" Bore X 2" Stroke S.D. Linear Actuator	1906069220
1 1/2" Bore X 1/2" Stroke S.D. Linear Actuator	1906069242
1 1/2" Bore X 1" Stroke S.D. Linear Actuator	1906069246
2" Bore X 3/8" Stroke S.D. Linear Actuator	1906069272
2" Bore X 1" Stroke S.D. Linear Actuator	1906069276
2 1/2" Bore X 1/2" Stroke S.D. Linear Actuator	1906069312
2 1/2" Bore X 1" Stroke S.D. Linear Actuator	1906069316
2 1/2" Bore X 2" Stroke S.D. Linear Actuator	1906069318
1/2" Bore X 1/2" Stroke D.D. Linear Actuator	1906069570
1/2" Bore X 1" Stroke D.D. Linear Actuator	1906069572

PARTS LIST

PNEUMATIC - ACTUATORS (cont.)

DESCRIPTION	PART NUMBER
3/4" Bore X 1" Stroke D.D. Linear Actuator	1906069592
1" Bore X 1" Stroke D.D. Linear Actuator	1906069612
1" Bore X 6" Stroke D.D. Linear Actuator <i>BULLWINKLE'S GUITAR</i>	1906069620
1 1/2" Bore X 1" Stroke D.D. Linear Actuator	1906069632
2" Bore X 1" Stroke D.D. Linear Actuator	1906069652
2" Bore X 1" Stroke <i>D.</i> Linear Actuator	1906069876

# AVG PRODUCTIONS FIGURE DATA LIST

BOX: \_\_\_\_\_

FIGURE: BULLWINKLE

SOURCE \_\_\_\_\_

FUNCTION	TYPE	PRIM. CONT.	COMPR. FUNC. NO.	LOCAL	ADDRESS CH. BIT	TRACK	FREQ	CONT. CABLE PAIR	PAIR COLOR
EYEBROWS	DIG		D1		2 0				
EYEBLINK	DIG		D2		2 1				
EYES RIGHT	DIG		D3		2 2				
EYES LEFT	DIG		D4		2 3				
EYES UP	DIG		D5		2 4				
EYES DOWN	DIG		D6		2 5				
MOUTH	DIG		D7		0 5				
HEAD NOD UP	DIG		D8		5 0				
HEAD TILT RT.	DIG		D9		5 1				
HEAD TILT LFT.	DIG		D10		5 2				
HEAD TURN	ANA		A1		17				
LFT ARM IN	DIG		D11		2 6				
LFT ARM OUT	DIG		D12		2 7				
LFT FINGERS	DIG		D13		5 3				







AVG PRODUCTIONS FIGURE DATA LIST

FIGURE: WATER SHOU

SOURCE

FUNCTION	TYPE	PRIM. CONT.	COMP. FUNC. NO.	LOCAL	ADDRESS CH. BIT	TRACK	FREQ	CONT. CABLE PAIR	PAIR COLOR
ROW 1			D1		13 0				
ROW 2			D2		13 1				
CAKE 1			D3		13 2				
CAKE 2			D4		13 3				
CAKE 3			D5		13 4				
CAKE CENTER			D6		13 5				
SYND JETS			D7		13 6				
CENTER SPIN			D8		13 7				
OUTER SPIN			D9		14 0				
BACK ROWS			D10		14 1				
FANS			D11		14 2				
LEFT TRUNION			D12		14 3				
RIGHT TRUNION			D13		14 4				
LEFT ARCH			D14		14 5				





# AVG PRODUCTIONS FIGURE DATA LIST

FIGURE: LIGHTING

FUNCTION	TYPE	PRIM. CONT.	COMP. FUNC. NO.	SOURCE		TRACK	FREQ	CONT. CABLE PAIR	PAIR COLOR
				LOCAL	ADDRESS CH. BIT				
BULLWINKLE	ANA.	CH.1			23				
ROCKY	ANA.	CH.2			24				
BORIS/NATASHA	ANA.	CH.3			25				
CURTAIN WASH	ANA.	CH.4			26				
BACKGROUND FILL	ANA.	CH.5			27				
WATER YELLOW	ANA.	CH.6			28				
WATER BLUE	ANA.	CH.7			29				
WATER RED	ANA.	CH.8			30				
STROBE	DIG.				15	3			
HOUSE LIGHTS	ANA.	CH.9			22				
		CH.10							
		CH.11							





# AVG PRODUCTIONS FIGURE DATA LIST

BOX: \_\_\_\_\_

FIGURE: \_\_\_\_\_ AUDIO

SOURCE \_\_\_\_\_

FUNCTION	TYPE	PRIM. CONT.	COMP. FUNC. NO.	LOCAL	ADDRESS CH. BIT	TRACK	FREQ	CONT. CABLE PAIR	PAIR COLOR
AMP 1 <sup>ADJUST</sup> LEFT MUSIC					0 0	#3			
AMP 2 RT MUSIC					0 1	#3			
AMP 3 CNTR MUSIC B/N					0 2	#1			
AMP 4 DUDLEY					1 0	#2			
AMP 5 TOOTER ROCKY					0 3	#1			
AMP 6 BULLWINKLE					1 1	#2			
AMP 7 HOPIITY					0 4	#1			
AMP 8 UNDERDOG					1 2	#2			

# AVG PRODUCTIONS FIGURE DATA LIST

BOX: \_\_\_\_\_

FIGURE: \_\_\_\_\_ CURTAINS

SOURCE \_\_\_\_\_

FUNCTION	TYPE	PRIM. CONT.	COMP. FUNC. NO.	LOCAL	ADDRESS CH. BIT	TRACK	FREQ	CONT. CABLE PAIR	PAIR COLOR
LEFT STAGE	DIG		D1		2 0				
CENTER STAGE	DIG		D2		2 1				
RIGHT STAGE	DIG		D3		2 2				

# AVG PRODUCTIONS FIGURE DATA LIST

BOX: \_\_\_\_\_

FIGURE: \_\_\_\_\_ LIGHTS

FUNCTION	TYPE	PRIM. CONT.	COMP. FUNC. NO.	LOCAL	ADDRESS CH. BIT	TRACK	FREQ	CONT. CABLE PAIR	PAIR COLOR
CH1. DUDLEY	DIG		D1		3 0	0-10V RAMP			
CH2. LFT FILL WASH	ANA		A1		24				
CH3. ROCKY, ETC.	DIG		D2		3 1	0-10V RAMP			
CH4. BULLWINKLE	DIG		D3		3 2	0-10V RAMP			
CH5. CNTR FILL WASH	ANA		A2		25				
CH6. UNDERDOG	DIG		D4		3 3	0-10V RAMP			
CH7 RT FILL WASH	ANA		A3		26				
CH8 BORIS/NATASHA	DIG		D5		3 4	0-10V RAMP			
CH9 STAGE FIGURE LTS	DIG		D6		3 5	0-10V RAMP			
CH10 STAGE FILL	ANA		A4		27				
CH11 WATER SH. YELLOW	ANA		A5		28				
CH12 WATER SH. BLUE	ANA		A6		29				
CH13 WATER SH. RED	ANA		A7		30				
STROBE LIGHT	DIG		D7		15 3				
CH14, 15, 16 HOUSE	ANA		A8		22				

# AVG PRODUCTIONS FIGURE DATA LIST

BOX: \_\_\_\_\_

FIGURE: DUDLEY

SOURCE \_\_\_\_\_

*CHARGE* ↙

FUNCTION	TYPE	PRIM. CONT.	COMP. FUNC. NO.	LOCAL	ADDRESS CH. BIT	TRACK	FREQ	CONT. CABLE PAIR	PAIR COLOR
EYEBROWS	DIG		D1		5 0			B	
EYEBLINK	DIG		D2		5 1			A	
EYES RIGHT	DIG		D3		5 2			A	
EYES LEFT	DIG		D4		5 3			B	
MOUTH	DIG		D5		4 0			B	
HEAD NOD	DIG		D6		5 4			B	
HEAD TURN	ANA		A1		16			-	
LFT. SHOULDER F/B	DIG		D7		5 5			B	
LFT. ARM I/O	DIG		D8		5 6			B	
LFT. ELBOW OUT	DIG		D9		5 7			B	
HIP TWIST RIGHT	DIG		D10		6 0			B	
HIP TWIST LEFT	DIG		D11		6 1			A	
GRAMAPHONE LIGHT	DIG		D12		6 6			-	
					6-4				









# AVG PRODUCTIONS FIGURE DATA LIST

BOX: \_\_\_\_\_

FIGURE: BULLWINKLE

SOURCE \_\_\_\_\_

FUNCTION	TYPE	PRIM. CONT.	COMP. FUNC. NO.	LOCAL	ADDRESS CH. BIT	TRACK	FREQ	CONT. CABLE PAIR	PAIR COLOR
EYEBROWS	DIG		D1		9 0			B	
EYEBLINK	DIG		D2		9 1			B	
EYES RIGHT	DIG		D3		9 2			A	
EYES LEFT	DIG		D4		9 3			B	
EYES UP	DIG		D5		9 4			B	
EYES DOWN	DIG		D6		9 5			A	
MOUTH	DIG		D7		4 3			A	
HEAD NOD <del>UP</del> down (open)	S DIG		D8		9 6			A	
					9 7				
HEAD TILT RIGHT	DIG		D10		10 0			A	
HEAD TILT LEFT	DIG		D11		10 1			B	
HEAD TURN	ANA		A1		20			F	
LEFT ARM SLIDE IN	DIG		D12		10 2			A	
LEFT ARM SLIDE OUT	DIG		D13		10 3			B	
					6-8				



# AVG PRODUCTIONS FIGURE DATA LIST

BOX: \_\_\_\_\_

FIGURE: UNDERDOG

SOURCE \_\_\_\_\_

FUNCTION	TYPE	PRIM. CONT.	COMP. FUNC. NO.	LOCAL	ADDRESS CH. BIT	TRACK	FREQ	CONT. CABLE PAIR	PAIR COLOR
EYEBROWS	DIG		D1		11 1			B	
EYEBLINK	DIG		D2		11 2			B	
EYES RIGHT	DIG		D3		11 3			B	
EYES LEFT	DIG		D4		11 4			A	
EYES UP	DIG		D5		11 5			B	
EYES DOWN	DIG		D6		11 6			A	
MOUTH	DIG		D7		4 4			B	
BODY F/B	DIG		D8		11 7			B	
SAX UP/DOWN	DIG		D9		12 0			B	
HEAD NOD	DIG		D10		12 1			B	
RT. HAND FINGER 1	DIG		D11		12 2			B	
TORSO TWIST	ANA		A1		21			-	
RT. HAND FINGER 2	DIG		D12		12 3			A	
					6-10				



# AVG PRODUCTIONS FIGURE DATA LIST

BOX: \_\_\_\_\_  
 FIGURE: \_\_\_\_\_ WATER SHOW

		SOURCE									
FUNCTION	TYPE	PRIM. CONT.	COMP. FUNC. NO.	LOCAL	ADDRESS CH. BIT	TRACK	FREQ	CONT. CABLE PAIR	PAIR COLOR		
OW 1			D1		13 0						
OW 2			D2		13 1						
AKE 1			D3		13 2						
AKE 2			D4		13 3						
AKE 3			D5		13 4						
AKE CENTER			D6		13 5						
INC JETS			D7		13 6						
ENTER SPIN			D8		13 7						
TER SPIN			D9		14 0						
CK ROW			D10		14 1						
NS			D11		14 2						
FT TRUNION			D12		14 3						
GHT TRUNION			D13		14 4						
FT ARCH			D14		14 5						







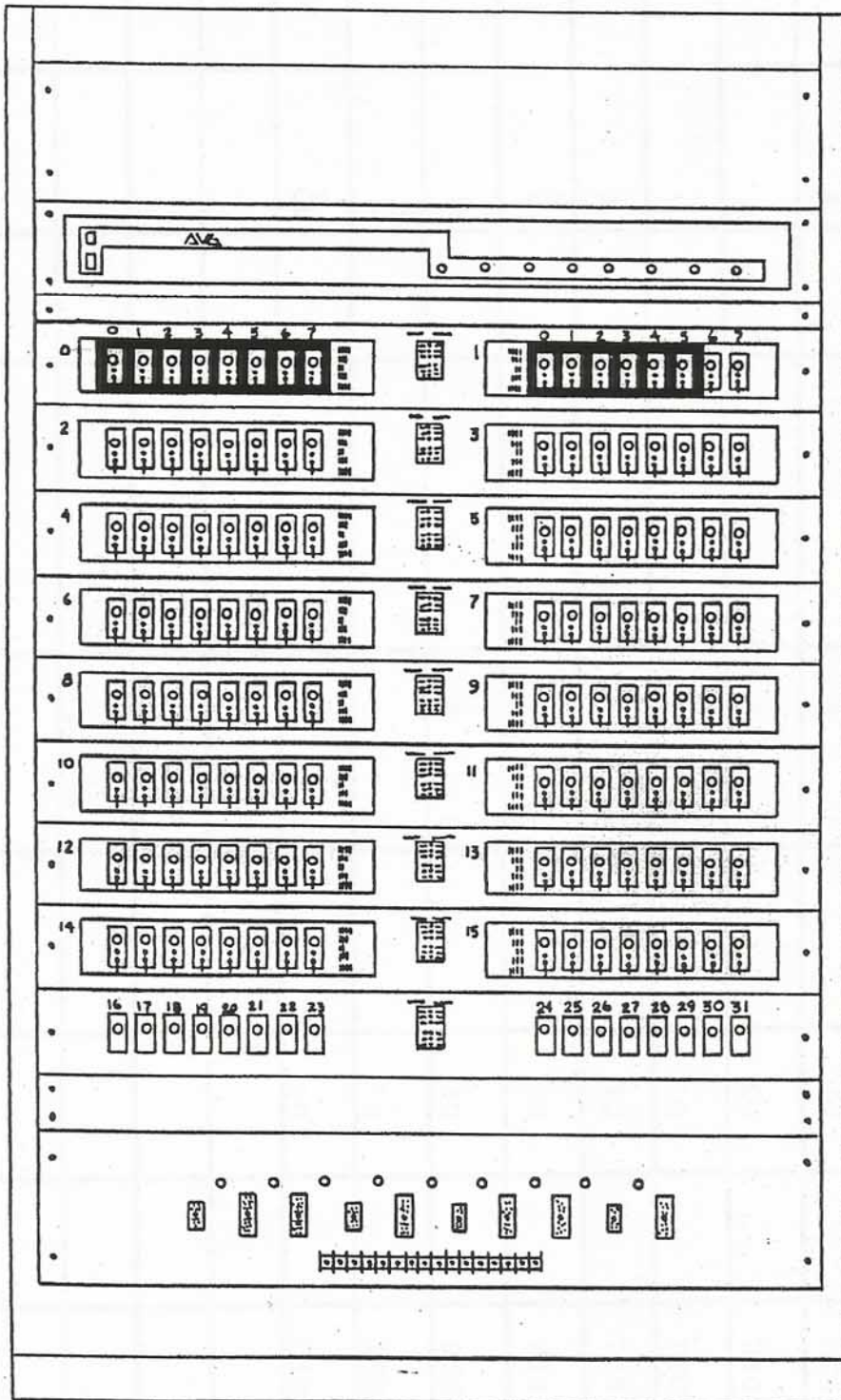

TECH - LABEL  
 ALL CHANNELS  
 ALL BITS AT  
 INSTALLATION

AUDIO SYSTEM'S FUNCTION  
BIT MAP

CENTER CURTAIN CYLINDER

RIGHT CURTAIN CYLINDER

CABLES

CURTAINS

WATER SHOW

FLOOR PANELS

STAGE

CURTAIN DIAGRAM

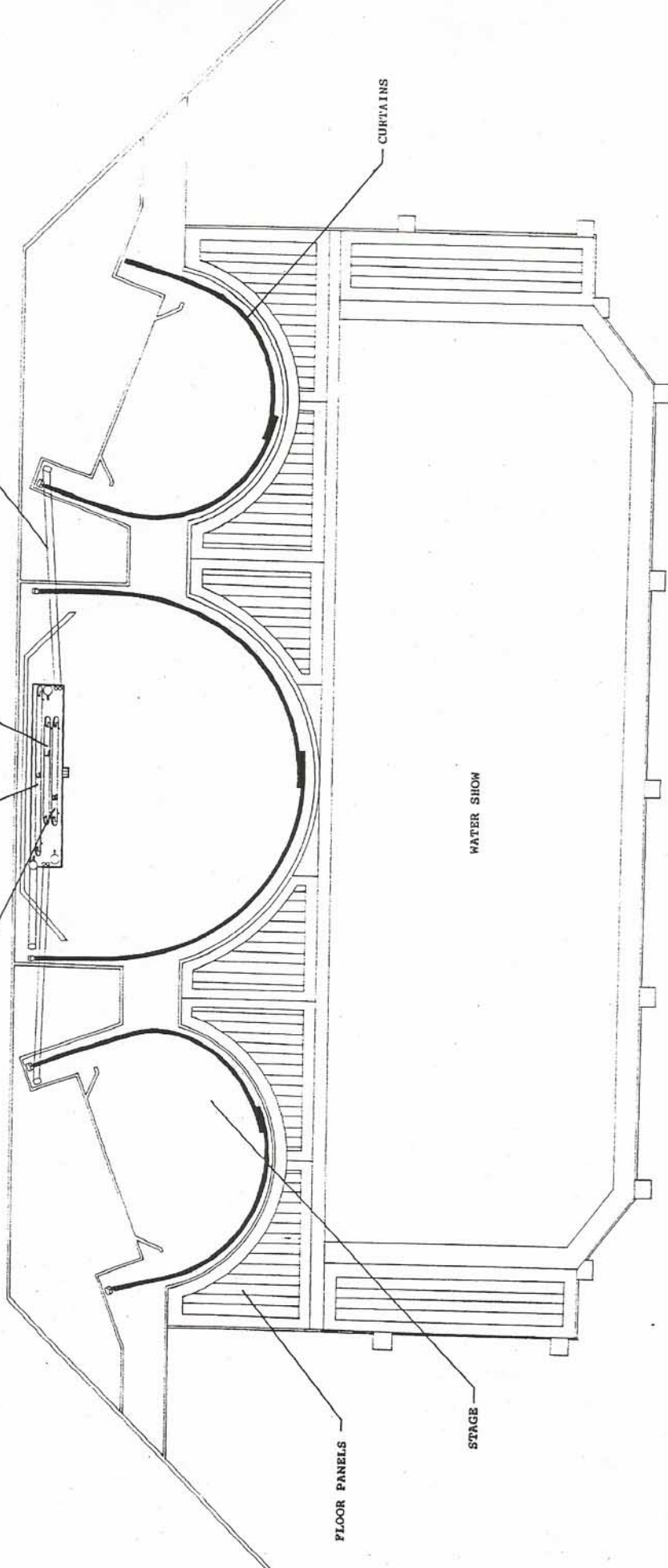

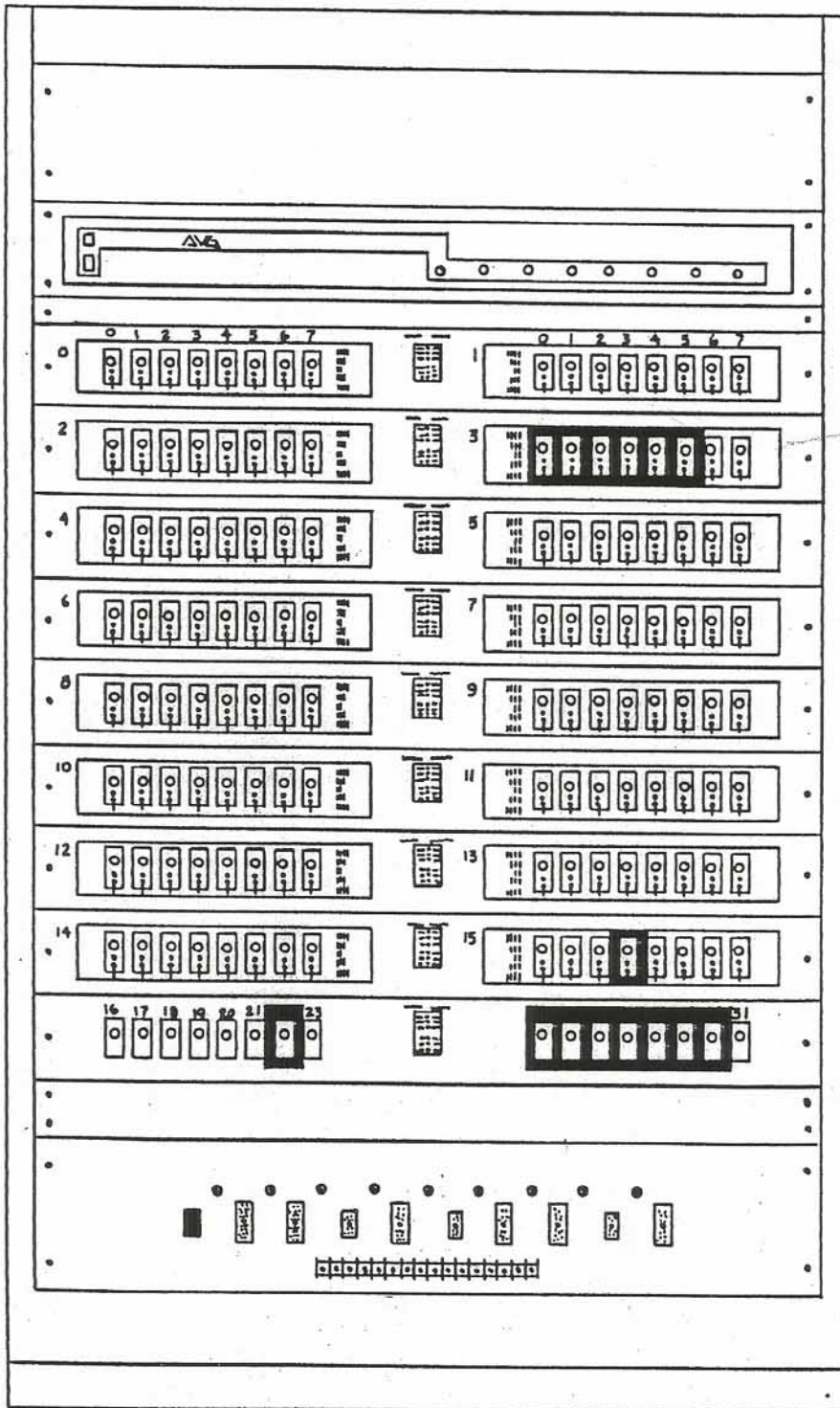

LIGHTING SYSTEM'S FUNCTION  
BIT MAP

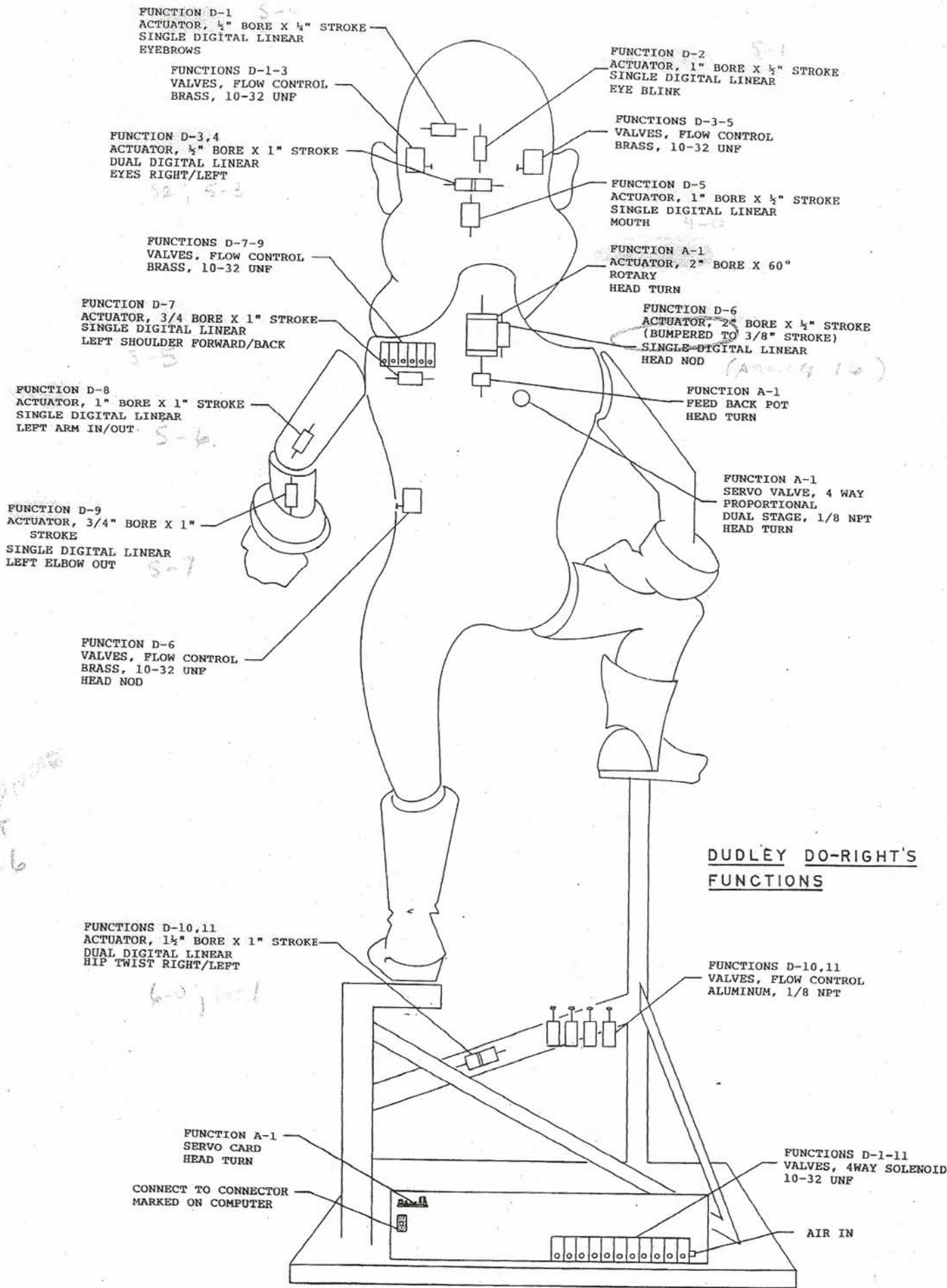

DUDLEY DO-RIGHT'S  
FUNCTIONS

*Handwritten:*  
6-6

FUNCTION D-1  
ACTUATOR, 1/2" BORE X 1/4" STROKE  
SINGLE DIGITAL LINEAR  
EYEBROWS

FUNCTION D-2  
ACTUATOR, 1" BORE X 1/2" STROKE  
SINGLE DIGITAL LINEAR  
EYE BLINK

FUNCTIONS D-1-3  
VALVES, FLOW CONTROL  
BRASS, 10-32 UNF

FUNCTIONS D-3-5  
VALVES, FLOW CONTROL  
BRASS, 10-32 UNF

FUNCTION D-3,4  
ACTUATOR, 1/2" BORE X 1" STROKE  
DUAL DIGITAL LINEAR  
EYES RIGHT/LEFT

FUNCTION D-5  
ACTUATOR, 1" BORE X 1/2" STROKE  
SINGLE DIGITAL LINEAR  
MOUTH

FUNCTIONS D-7-9  
VALVES, FLOW CONTROL  
BRASS, 10-32 UNF

FUNCTION A-1  
ACTUATOR, 2" BORE X 60°  
ROTARY  
HEAD TURN

FUNCTION D-7  
ACTUATOR, 3/4 BORE X 1" STROKE  
SINGLE DIGITAL LINEAR  
LEFT SHOULDER FORWARD/BACK

FUNCTION D-6  
ACTUATOR, 2" BORE X 1/2" STROKE  
(BUMPERED TO 3/8" STROKE)  
SINGLE DIGITAL LINEAR  
HEAD NOD

FUNCTION D-8  
ACTUATOR, 1" BORE X 1" STROKE  
SINGLE DIGITAL LINEAR  
LEFT ARM IN/OUT

FUNCTION A-1  
FEED BACK POT  
HEAD TURN

FUNCTION D-9  
ACTUATOR, 3/4" BORE X 1"  
STROKE  
SINGLE DIGITAL LINEAR  
LEFT ELBOW OUT

FUNCTION A-1  
SERVO VALVE, 4 WAY  
PROPORTIONAL  
DUAL STAGE, 1/8 NPT  
HEAD TURN

FUNCTION D-6  
VALVES, FLOW CONTROL  
BRASS, 10-32 UNF  
HEAD NOD

FUNCTIONS D-10,11  
ACTUATOR, 1 1/2" BORE X 1" STROKE  
DUAL DIGITAL LINEAR  
HIP TWIST RIGHT/LEFT

FUNCTIONS D-10,11  
VALVES, FLOW CONTROL  
ALUMINUM, 1/8 NPT

FUNCTION A-1  
SERVO CARD  
HEAD TURN

FUNCTIONS D-1-11  
VALVES, 4WAY SOLENOID  
10-32 UNF

CONNECT TO CONNECTOR  
MARKED ON COMPUTER

AIR IN

FUNCTIONS D-1,2  
ACTUATOR, 1/2" BORE X 1/2" STROKE  
DUAL DIGITAL LINEAR  
EYES RIGHT/LEFT

FUNCTIONS D-1-4  
VALVES, FLOW CONTROL  
BRASS, 10-32 UNF

FUNCTIONS D-3,4  
ACTUATOR, 3/4" BORE X 1"  
STROKE  
DUAL DIGITAL LINEAR  
HARMONICA RIGHT/LEFT

FUNCTION A-1  
ACTUATOR, 1 1/2" BORE X 30°  
ROTARY  
BODY TWIST

FUNCTION A-1  
FEED BACK POT  
BODY TWIST

FUNCTION A-1  
SERVO VALVE, 4 WAY  
PROPORTIONAL  
SINGLE STAGE, 1/8 NPT  
BODY TWIST

HOPPITY HOOPER'S  
FUNCTIONS

FUNCTIONS D-1-4  
VALVES, 4 WAY SOLENOID  
10-32 UNF

AIR IN

FUNCTION A-1  
SERVO CARD  
BODY TWIST

CONNECT TO CONNECTOR  
MARKED ON COMPUTER

# ROCKY'S FUNCTIONS

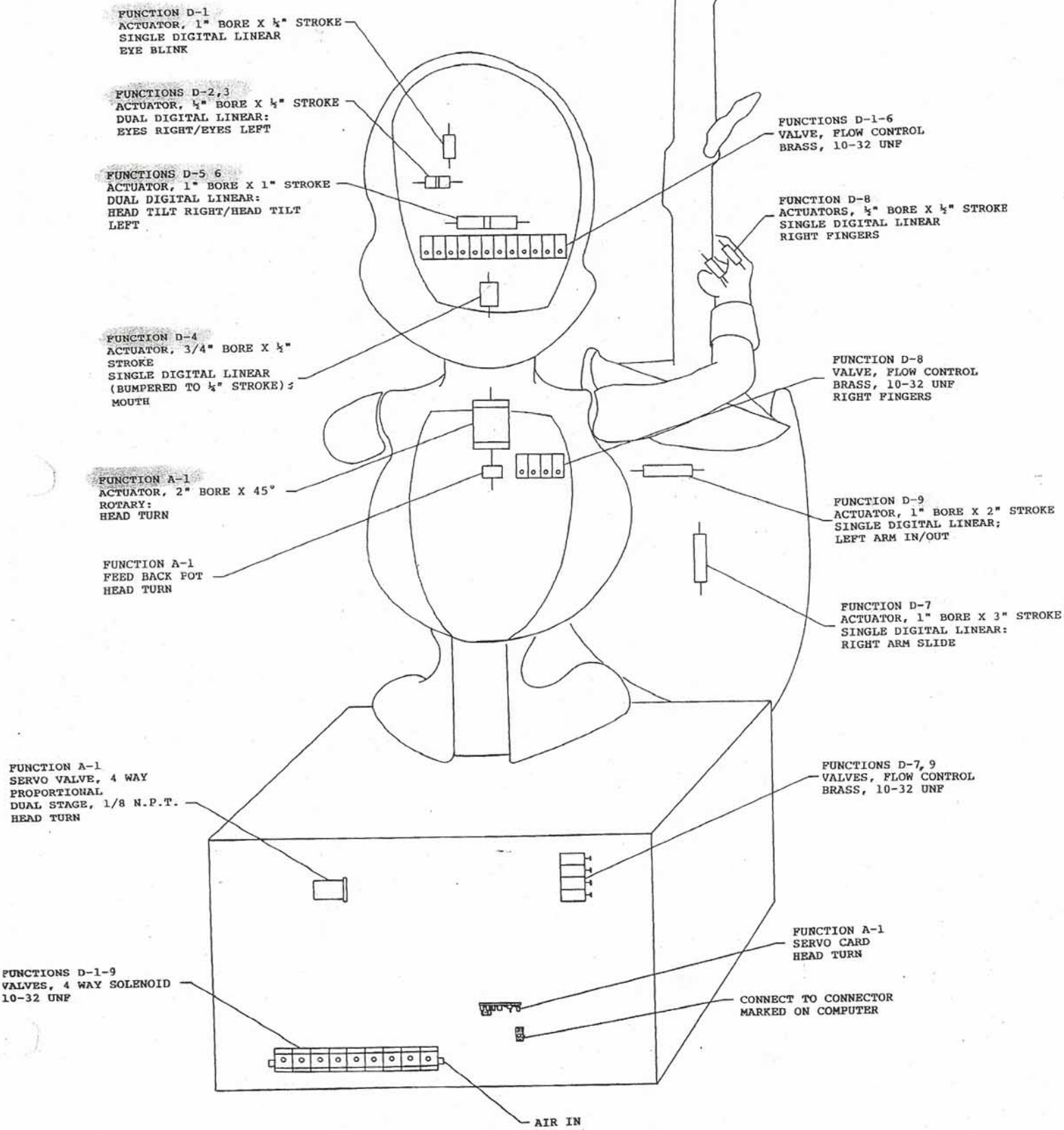



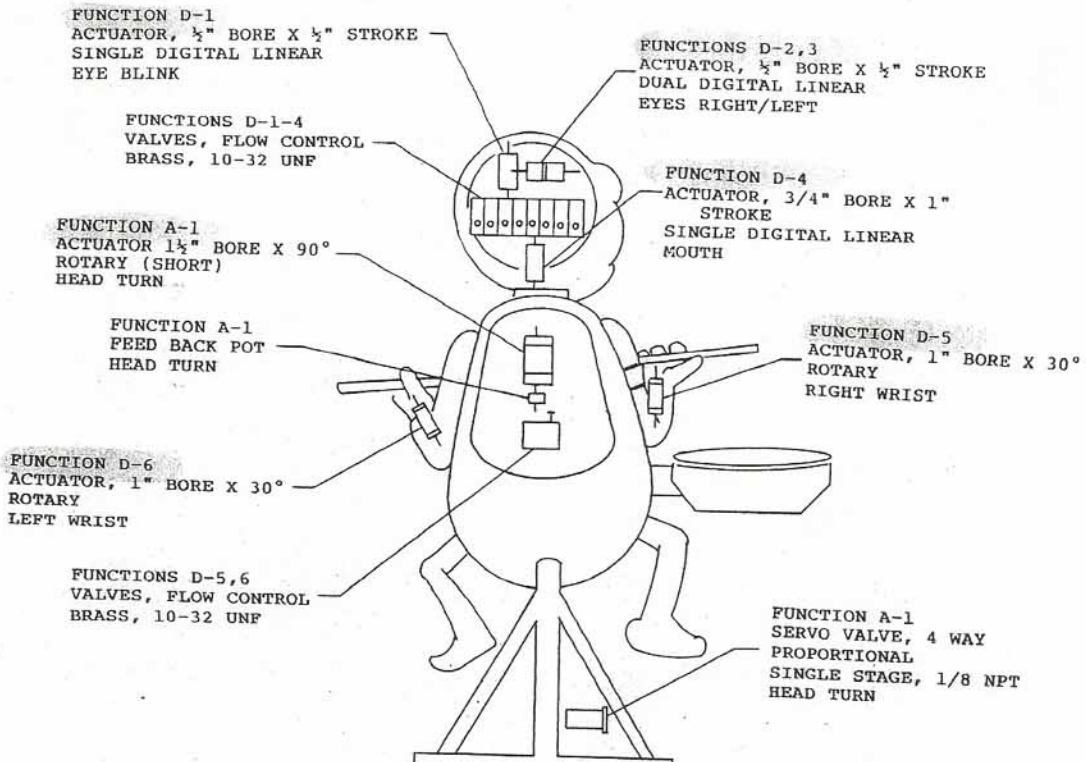

TOOTER TURTLE'S  
FUNCTIONS

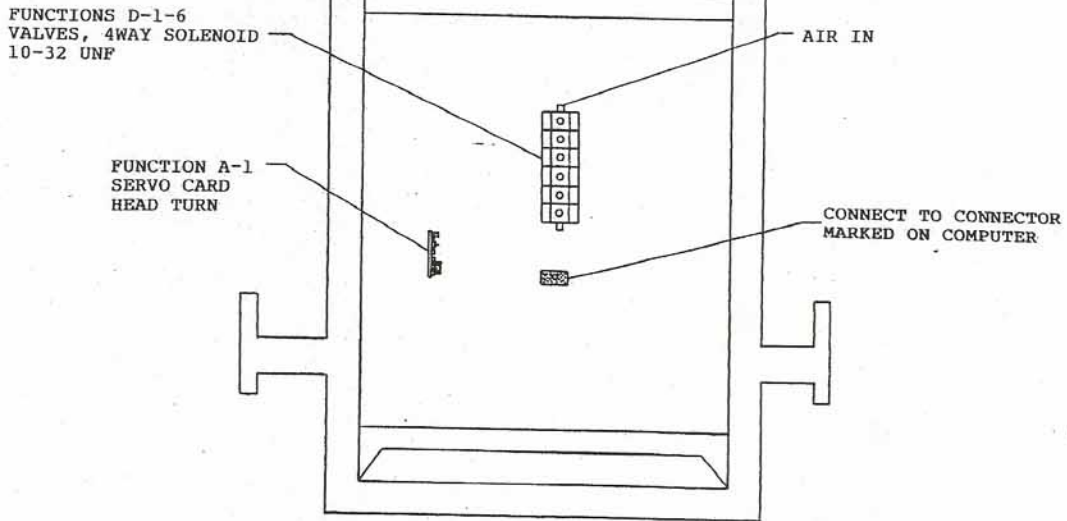

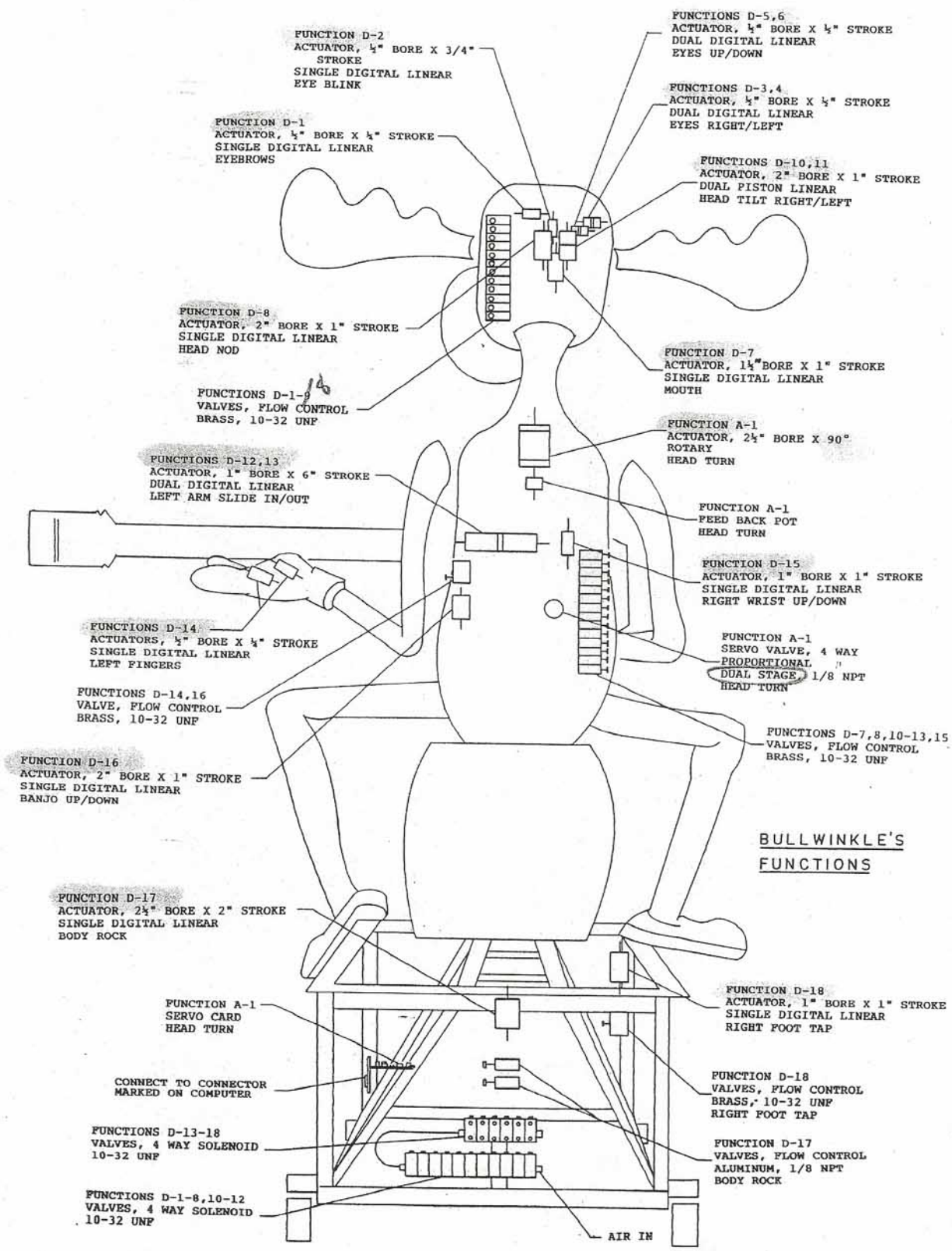

**BULLWINKLE'S  
FUNCTIONS**

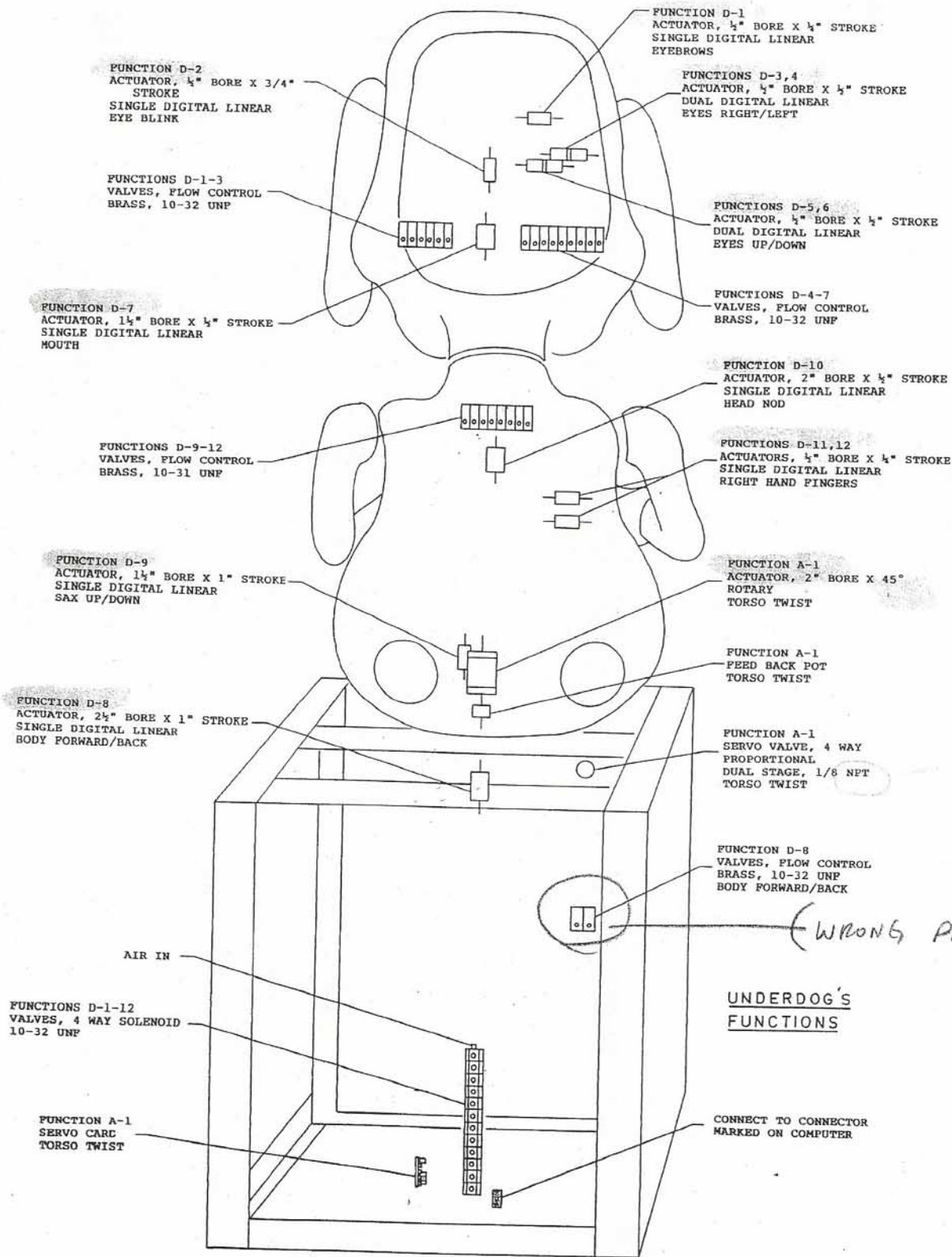

UNDERDOG'S  
FUNCTIONS

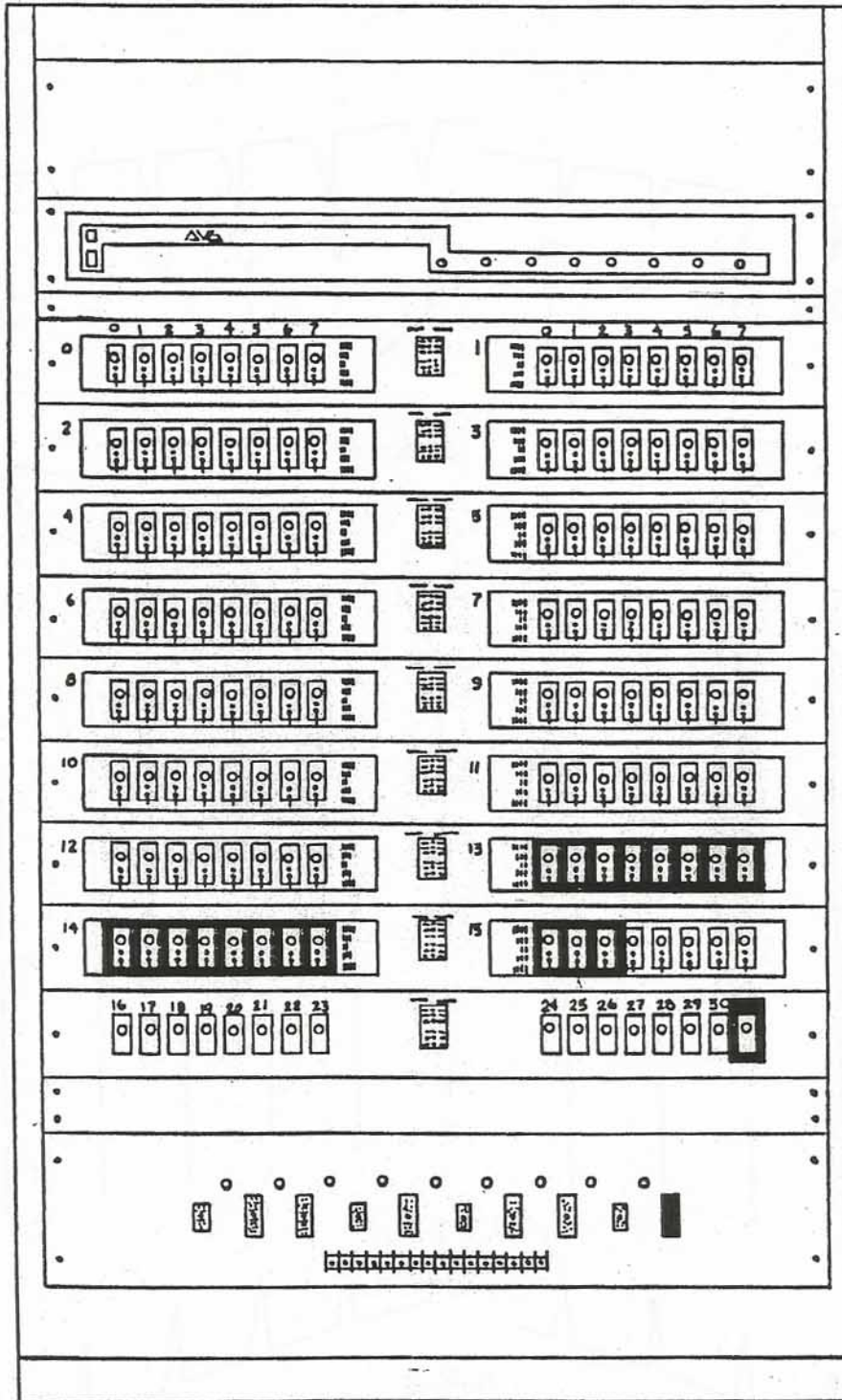

WATER SHOW'S FUNCTION  
BIT MAP

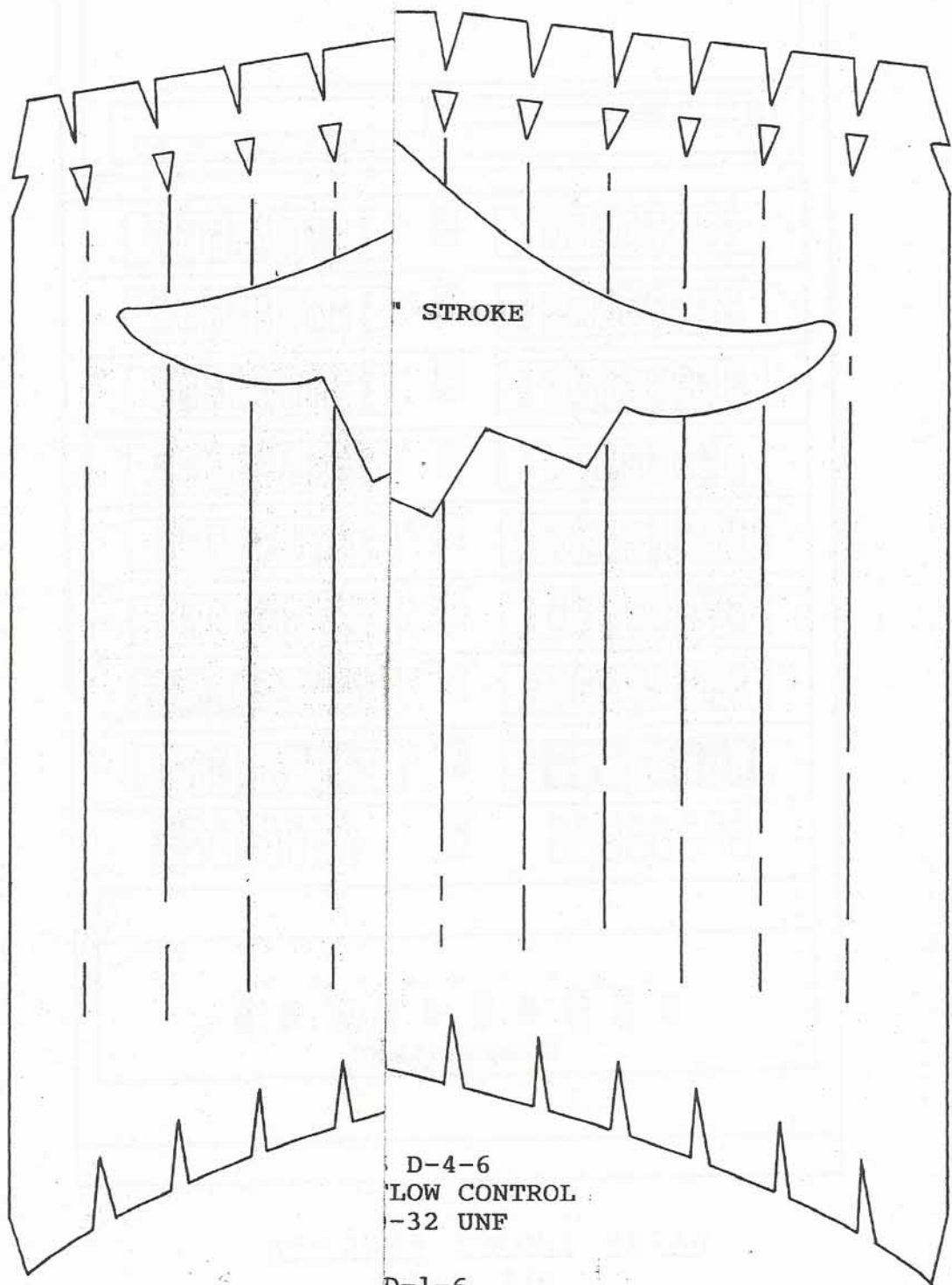

" STROKE

D-4-6  
LOW CONTROL  
-32 UNF

D-1-6  
WAY SOLENOID

FUNCTION -4,5  
ACTUATOR BORE X 1/2" STROKE  
SINGLE LINEAR  
BORIS RIGHT/LEFT

BIT NO.	FUNCTION NO.	FUNCTION DESCRIPTION
8	D-1	EYEBROWS
7	D-2	EYE BLINK
6	D-3	EYES RIGHT/LEFT
5	D-4	EYES RIGHT/LEFT
4	D-5	MOUTH
3	D-6	HEAD TURN RIGHT/LEFT
2	D-7	HEAD TURN RIGHT/LEFT
1	D-8	STICH TILT

PINS NO. 1-35 ODD, TOP  
NO. 2-36 EVEN, BOTTOM

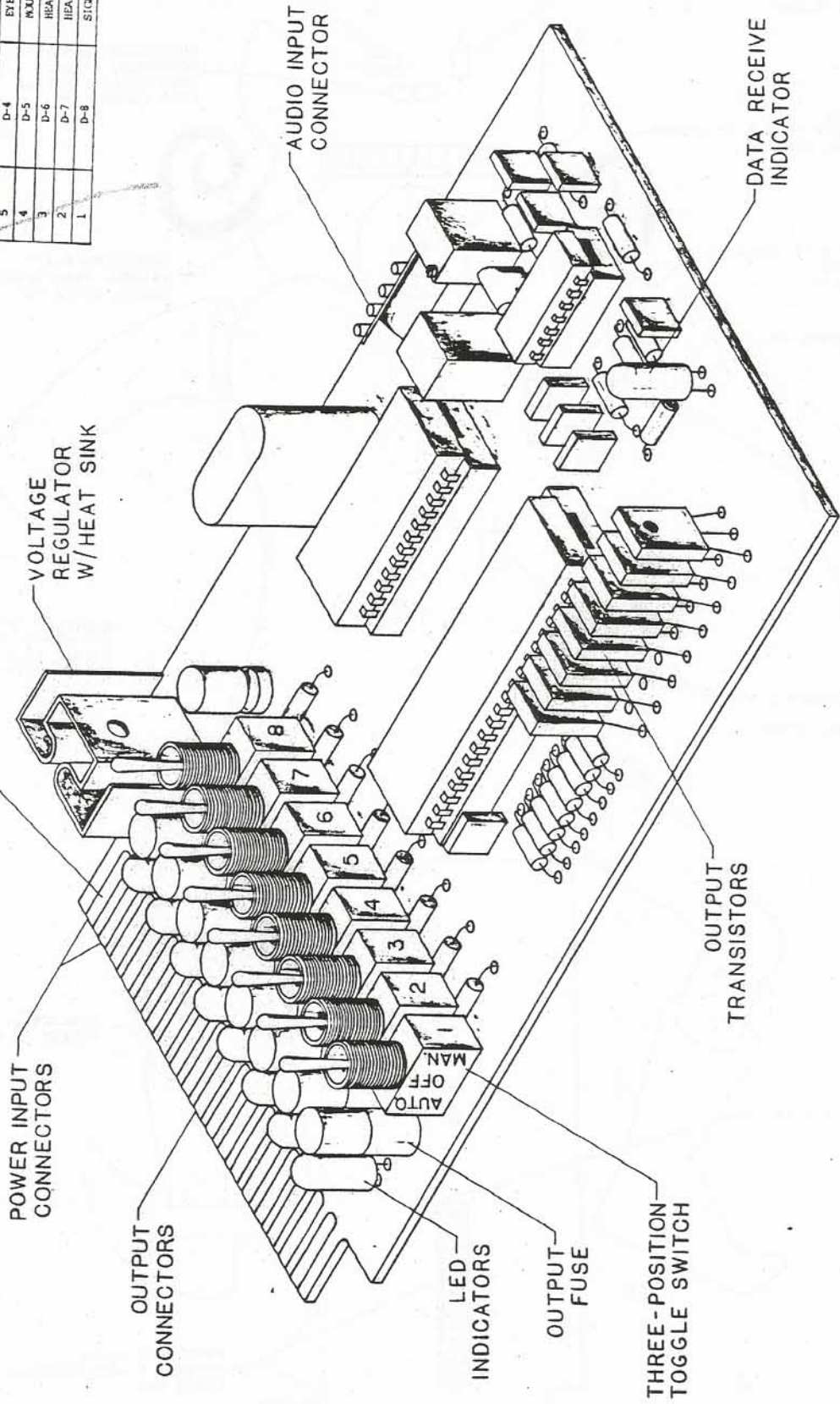

SNIDELY'S CONTROL MODULE

PINS NO. 1-35 ODD, TOP  
NO. 2-36 EVEN, BOTTOM

BIT NO.	FUNCTION NO.	FUNCTION DESCRIPTION
0	D-1	EXPOSURE
1	D-2	EYE BLINK
2	D-3	EYES RIGHT/LEFT
3	D-4	EYES RIGHT/LEFT
4	D-5	PCOPII
5	D-6	HEAD TURN RIGHT/LEFT
6	D-7	HEAD TURN RIGHT/LEFT
7	D-8	SIGN TILT

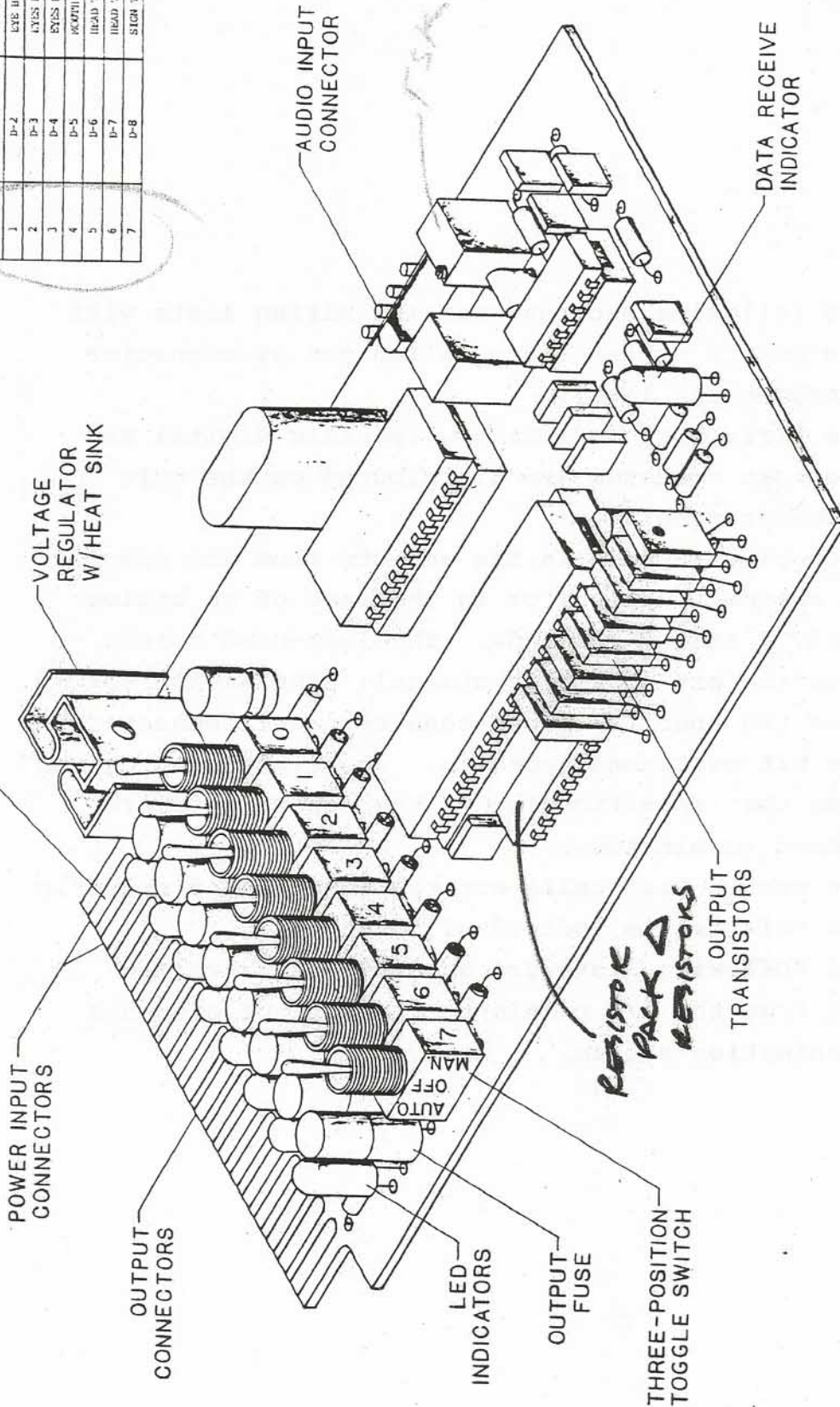

SNIDELY'S CONTROL MODULE

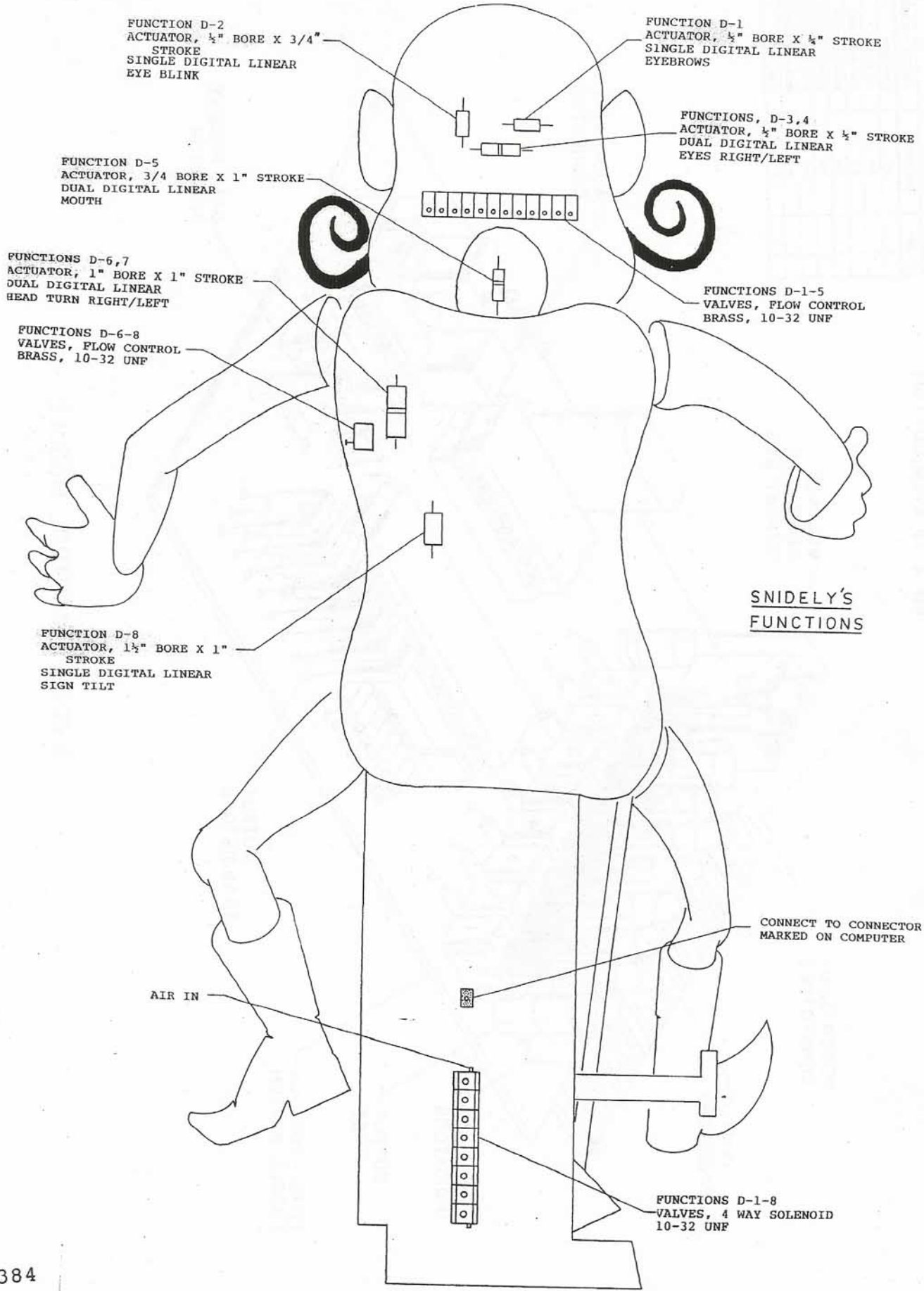

FUNCTION D-2  
ACTUATOR, 1/2" BORE X 3/4"  
STROKE  
SINGLE DIGITAL LINEAR  
EYE BLINK

FUNCTION D-1  
ACTUATOR, 1/2" BORE X 1/2" STROKE  
SINGLE DIGITAL LINEAR  
EYEBROWS

FUNCTIONS, D-3,4  
ACTUATOR, 1/2" BORE X 1/2" STROKE  
DUAL DIGITAL LINEAR  
EYES RIGHT/LEFT

FUNCTION D-5  
ACTUATOR, 3/4 BORE X 1" STROKE  
DUAL DIGITAL LINEAR  
MOUTH

FUNCTIONS D-6,7  
ACTUATOR, 1" BORE X 1" STROKE  
DUAL DIGITAL LINEAR  
HEAD TURN RIGHT/LEFT

FUNCTIONS D-1-5  
VALVES, FLOW CONTROL  
BRASS, 10-32 UNF

FUNCTIONS D-6-8  
VALVES, FLOW CONTROL  
BRASS, 10-32 UNF

SNIDELY'S  
FUNCTIONS

FUNCTION D-8  
ACTUATOR, 1 1/2" BORE X 1"  
STROKE  
SINGLE DIGITAL LINEAR  
SIGN TILT

CONNECT TO CONNECTOR  
MARKED ON COMPUTER

AIR IN

FUNCTIONS D-1-8  
VALVES, 4 WAY SOLENOID  
10-32 UNF



The following section contains wiring lists with specific points of interface called out at connector and connector pin level.

The first list defines how specific digital and analog output commands are distributed on the main cross-connect panel.

Each page represents the outputs from one specific digital channel, 8 bits, or in the case of an analog I/O panel, 8 analog commands. The left-hand column indicates the bit or analog channel. The middle column indicates the specific cross-connect panel connector that the bit or channel goes to. The right-hand column indicates that specific pins in the connector where the command terminates.

The second list calls out the location of specific commands relative to individual connector.

The following lists are essential for tracing commands from the I/O panels to the various elements of the animation system.

ELCO CONN. PIN PAIRS

56 PIN

Connector BULLWINKLE

PAIR	FUNC.
1. A B	D1 Red BLK
2. C D	D2 WH BLK
3. E F	D3 GRN BLK
4. H J	D4 Blue BLK
5. K L	D5 BRN BLK
6. M N	D6 YLW BLK
7. P R	D7 OR BK
8. S T	D8 Red GRN
9. U V	D9 R W
10. W X	D10 RB Blue
11. Y Z	D11 Red Yell

PAIR	FUNC.
12. a b	D12 Red Brown *
13. c d	D13 Red GRY *
14. e f	D14 GRN Blue *
15. h j	D15 GRN White *
16. k l	D16 GRN Brown *
17. m n	D17 G Crem *
18. p r	-
19. s t	A1 GR Y
20. u v	
21. w x	
22. y z	
23. AA BB	+ 24VDC W GND. BLUE

BL/Y  
BR/W  
Y/W  
OR/W

NOT  
USED

ELCO CONN. PIN PAIRS  
20 + 38 PIN

Connector ROCKY

<u>PAIR</u>	<u>FUNC.</u>	
1. A B	D1	Red Blk
2. C D	D2	W B
3. E F	D3	G B
4. H J	D4	Blue Blk
5. K L	D5	brown Black
6. M N	D6	V B
7. P R	D7	GRY. B
8. S T	D8	Red W * *
9. U V	D9	Red W *
10. W X	A1	R BLUE
11. Y Z		

<u>PAIR</u>	<u>FUNC.</u>	
12. AA BE		
13. CC DD		
14. EE FF		
15. HH JJ		
16. KK LL		
17. MM NN		
18. PP RR		
19. SS TT	+24 VDC GND	R X

R/BA  
R/OR  
GR/W.  
GR/BL

NOT USED

ELCO CONN. PIN PAIRS

20 + 38 PIN

Connector BORIS + NATASHA

<u>PAIR</u>	<u>FUNC.</u>	
1. A B	D1	Red BK
2. C D	D2	Yell BK
3. E F	D3	Green BK
4. H J	D4	Blue BK
5. K L	D5	Brown BK
6. M N	D6	Yell / BK
7. P R		
8. S T		
9. U V		
10. W X		
11. Y Z		

<u>PAIR</u>	<u>FUNC.</u>
12. AA BE	
13. CC DD	
14. EE FF	
15. HH JJ	
16. KK LL	
17. MM NN	
18. PP RR	
19. SS TT	

ELCO CONN. PIN PAIRS

Connector CURTAINS

<u>PAIR</u>	<u>FUNC.</u>
1. A B	<u>CURTAINS OPEN</u> <i>Red Black</i>
2. C D	_____
3. E F	_____
4. H J	_____
5. K L	_____
6. M N	_____
7. P R	_____
8. S T	_____
9. U V	_____
10. W X	_____
11. Y Z	_____

<u>PAIR</u>	<u>FUNC.</u>
12. AA BE	_____
13. CC DD	_____
14. EE FF	_____
15. HH JJ	_____
16. KK LL	_____
17. MM NN	_____
18. PP RR	_____
19. SS TT	_____

ELCO CONN. PIN PAIRS

56 PIN

Connector WATER SHOW

<u>PAIR</u>	<u>FUNC.</u>
1. A B	D1 Red Blk
2. C D	D2 Wh Blk
3. E F	D3 G Blk
4. H J	D4 Blue Black
5. K L	D5 Brown Black
6. M N	D6 Yell Blk
7. P R	D7 Org Blk
8. S T	D8 Red Green
9. U V	D9 Red White
10. W X	D10 Red Blue
11. Y Z	D11 Red Yellow

<u>PAIR</u>	<u>FUNC.</u>
12. a b	D12 Red Brown
13. c d	D13 Red Org
14. e f	D14 Green Blue
15. h j	D15 G White
16. k l	D16 G Brown
17. m n	D17 G Org
18. p r	D18 G Yell
19. s t	D19 White Blue
20. u v	A1 W BROWN
21. w x	
22. y z	
23. AA BB	

BL/Y - NOT USED

Y/W - NOT USED

ELCO CONN. PIN PAIRS

Connector LIGHTING

<u>PAIR</u>	<u>FUNC.</u>		<u>PAIR</u>	<u>FUNC.</u>
1. A B	<u>CH 1 BULLWINKLE</u>	<i>Red Blk</i>	12. AA BE	_____
2. C D	<u>CH 2 ROCKY</u>	<i>White Blk</i>	13. CC DD	_____
3. E F	<u>CH 3 BORIS/NAT.</u>	<i>G B. Blue Blk</i>	14. EE FF	_____
4. H J	<u>CH 4 WASH</u>		15. HH JJ	_____
5. K L	<u>CH 5 BACKGROUND</u>	<i>Brown Blk</i>	16. KK LL	_____
6. M N	<u>CH 6 WATER YELLOW</u>	<i>Yell Blk</i>	17. MM NN	_____
7. P R	<u>CH 7 WATER BLUE</u>	<i>Org Black</i>	18. PP RR	_____
8. S T	<u>CH 8 WATER RED</u>	<i>Red Green</i>	19. SS TT	_____
9. U V	<u>CH 9, 10, 11, HOUSE</u>	<i>Red White</i>		
10. W X	<u>STROBE (15 3)</u>	<i>Red Blue</i>		
11. Y Z	_____			

I/O CABLE GUIDE

CABLE     A1    

PAIR	FUNCTION CH/BIT	TERMINATING CONN	CONN PIN
1. <u>  16  </u>	<u>  A1  </u>	<u>  DUDLEY  </u> ✓	+ AA <u>  39  </u> - BB <u>  40  </u>
2. <u>  17  </u>	<u>  A1  </u>	<u>  HOPPITY  </u> ✓	+ K <u>  37  </u> - L <u>  38  </u>
3. <u>  18  </u>	<u>  A1  </u>	<u>  ROCKY  </u>	+ W <u>  35  </u> - X <u>  36  </u>
4. <u>  19  </u>	<u>  A1  </u>	<u>  TOOTER  </u>	+ P <u>  33  </u> - R <u>  34  </u>
5. <u>  20  </u>	<u>  A1  </u>	<u>  BULLWINKLE  </u>	+ S <u>  29  </u> - t <u>  30  </u>
6. <u>  21  </u>	<u>  A1  </u>	<u>  UNDERDOG  </u>	+ CC <u>  27  </u> - DD <u>  28  </u>
7. <u>  22  </u>	<u>  TERM  </u>	<u>          </u> ✓	+ <u>          </u> <u>  25  </u> - <u>          </u> <u>  26  </u>
8. <u>  23  </u>	<u>  TERM  </u>	<u>          </u> ✓	+ <u>          </u> <u>  23  </u> - <u>          </u> <u>  24  </u>
9. <u>  +24VDC  </u>	<u>          </u>	<u>          </u>	+ <u>          </u> - <u>          </u>
10. <u>          </u>	<u>          </u>	<u>          </u>	+ <u>          </u> - <u>          </u>
11. <u>          </u>	<u>          </u>	<u>          </u>	+ <u>          </u> - <u>          </u>
12. <u>          </u>	<u>          </u>	<u>          </u>	+ <u>          </u> - <u>          </u>



I/O CABLE GUIDE

CABLE           A2          

PAIR	FUNCTION CH/BIT	TERMINATING CONN	CONN PIN
1. <u>24</u>	<u>A1</u>	<u>DIMMERS</u>	+ <u>C 19</u> - <u>D 20</u>
2. <u>25</u>	<u>A2</u>	<u>DIMMERS</u>	+ <u>K 17</u> - <u>L 18</u>
3. <u>26</u>	<u>A3</u>	<u>DIMMERS</u>	+ <u>P 15</u> - <u>R 16</u>
4. <u>27</u>	<u>A4</u>	<u>DIMMERS</u>	+ <u>W 13</u> - <u>X 14</u>
5. <u>28</u>	<u>A5</u>	<u>DIMMERS</u>	+ <u>Y 9</u> - <u>Z 10</u>
6. <u>29</u>	<u>A6</u>	<u>DIMMERS</u>	+ <u>AA 7</u> - <u>BB 8</u>
7. <u>30</u>	<u>A7</u>	<u>DIMMERS</u>	+ <u>CC 5</u> - <u>DD 6</u>
8. <u>31</u>	<u>A1</u>	<u>WATER SHOW</u>	+ <u>U 3</u> - <u>V 4</u>
9. <u>+24VDC</u>			+ _____ - _____
10. _____			+ _____ - _____
11. _____			+ _____ - _____
12. _____			+ _____ - _____

I/O CABLE GUIDE

CABLE \_\_\_\_\_ CO \_\_\_\_\_

PAIR	FUNCTION CH/BIT	TERMINATING CONN	CONN PIN
1. D1	0/0	COMP.	+ A - B
2. D2	0/1	COMP.	+ C - D
3. D3	0/2	COMP.	+ E - F
4. D4	0/3	COMP.	+ H - J
5. D5	0/4	COMP.	+ K - L
6. D6	0/5	COMP.	+ M - N
7. D7	0/6	COMP.	+ P - R
8. D8	0/7	COMP.	+ S - T
9. TERMINATE			+ -
10.			+ -
11.			+ -
12.			+ -

I/O CABLE GUIDE

CABLE     C1    

PAIR	FUNCTION CH/BIT	TERMINATING CONN	CONN PIN
1. <u>D1</u>	<u>                    </u>	<u>AUDIO MODULE</u>	+ <u>                    </u> - <u>                    </u>
2. <u>D2</u>	<u>                    </u>	<u>AUDIO MODULE</u>	+ <u>                    </u> - <u>                    </u>
3. <u>D3</u>	<u>                    </u>	<u>AUDIO MODULE</u>	+ <u>                    </u> - <u>                    </u>
4. <u>D4</u>	<u>                    </u>	<u>AUDIO MODULE</u>	+ <u>                    </u> - <u>                    </u>
5. <u>D5</u>	<u>                    </u>	<u>AUDIO MODULE</u>	+ <u>                    </u> - <u>                    </u>
6. <u>D6</u>	<u>                    </u>	<u>AUDIO MODULE</u>	+ <u>                    </u> - <u>                    </u>
7. <u>D7</u>	<u>                    </u>	<u>AUDIO MODULE</u>	+ <u>                    </u> - <u>                    </u>
8. <u>D8</u>	<u>                    </u>	<u>AUDIO MODULE</u>	+ <u>                    </u> - <u>                    </u>
9. <u>                    </u>	<u>                    </u>	<u>                    </u>	+ <u>                    </u> - <u>                    </u>
10. <u>                    </u>	<u>                    </u>	<u>                    </u>	+ <u>                    </u> - <u>                    </u>
11. <u>                    </u>	<u>                    </u>	<u>                    </u>	+ <u>                    </u> - <u>                    </u>
12. <u>                    </u>	<u>                    </u>	<u>                    </u>	+ <u>                    </u> - <u>                    </u>

I/O CABLE GUIDE

CABLE       C2      

PAIR	FUNCTION CH/BIT	TERMINATING CONN	CONN PIN
1.	D1	CURTAINS	+ A
			- B
2.	D2	CURTAINS	+ C
			- D
3.	D3	CURTAINS	+ E
			- F
4.	D4	CURTAINS	+ H
			- J
5.	D5	CURTAINS	+ K
			- L
6.	D6	CURTAINS	+ M
			- N
7.	TERM		+ _____
			- _____
8.	TERM		+ _____
			- _____
9.	TERM		+ _____
			- _____
10.			+ _____
			- _____
11.			+ _____
			- _____
12.			+ _____
			- _____

I/O CABLE GUIDE

CABLE       C3      

PAIR	FUNCTION CH/BIT	TERMINATING CONN	CONN PIN
1.	D1	DIMMER	+ A - B
2.	D2	DIMMER	+ E - F
3.	D3	DIMMER	+ H - J
4.	D4	DIMMER	+ M - N
5.	D5	DIMMER	+ S - T
6.	D6	DIMMER	+ U - V
7.	D8	DIMMER	+ HH - JJ
8.	TERM		+ -
9.	TERM		+ -
10.			+ -
11.			+ -
12.			+ -

I/O CABLE GUIDE

CABLE     C4    

PAIR	FUNCTION CH/BIT	TERMINATING CONN	CONN PIN
1.	D5	DUDLEY	+ K - L
2.	D4	ROCKY	+ H - J
3.	D4	TOOTER	+ H - J
4.	D7	BULLWINKLE	+ P - K
5.	D7	UNDERDOG	+ P - R
6.	D3	BORIS/NATASHA	+ E - F
7.	D6	BORIS/NATASHA	+ M - N
8.	TERM		+ -
9.	TERM		+ -
10.			+ -
11.			+ -
12.			+ -

I/O CABLE GUIDE

CABLE     C5    

PAIR	FUNCTION CH/BIT	TERMINATING CONN	CONN PIN
1.	D1	DUDLEY	+ A - B
2.	D2	DUDLEY	+ C - D
3.	D3	DUDLEY	+ E - F
4.	D4	DUDLEY	+ H - J
5.	D6	DUDLEY	+ M - N
6.	D7	DUDLEY	+ P - R
7.	D8	DUDLEY	+ S - T
8.	D9	DUDLEY	+ U - V
9.	+ 24 VDC	DUDLEY	+ SS - TT
10.			+ -
11.			+ -
12.			+ -

I/O CABLE GUIDE

CABLE          C6         

PAIR	FUNCTION CH/BIT	TERMINATING CONN	CONN PIN
1.	D10	DUDLEY	+ W - X
2.	D11	DUDLEY	+ Y - Z
3.	D1	HOPPITY	+ A - B
4.	D2	HOPPITY	+ C - D
5.	D3	HOPPITY	+ E - F
6.	D4	HOPPITY	+ H - J
7.	D12	DUDLEY	+ CC - DD
8.	TERM		+ -
9.	+ 24VDC	HOPPITY	+ W - X
10.			+ -
11.			+ -
12.			+ -



I/O CABLE GUIDE

CABLE       C7      

PAIR	FUNCTION CH/BIT	TERMINATING CONN	CONN PIN
1.	<u>      D1      </u>	<u>      ROCKY      </u>	+ <u>      A      </u> - <u>      B      </u>
2.	<u>      D2      </u>	<u>      ROCKY      </u>	+ <u>      C      </u> - <u>      D      </u>
3.	<u>      D3      </u>	<u>      ROCKY      </u>	+ <u>      E      </u> - <u>      F      </u>
4.	<u>      D5      </u>	<u>      ROCKY      </u>	+ <u>      K      </u> - <u>      L      </u>
5.	<u>      D6      </u>	<u>      ROCKY      </u>	+ <u>      M      </u> - <u>      N      </u>
6.	<u>      D7      </u>	<u>      ROCKY      </u>	+ <u>      P      </u> - <u>      R      </u>
7.	<u>      D8      </u>	<u>      ROCKY      </u>	+ <u>      S      </u> - <u>      T      </u>
8.	<u>      D9      </u>	<u>      ROCKY      </u>	+ <u>      U      </u> - <u>      V      </u>
9.	<u>  + 24VDC      </u>	<u>      ROCKY      </u>	+ <u>      SS      </u> - <u>      TT      </u>
10.	<u>                  </u>	<u>                  </u>	+ <u>              </u> - <u>              </u>
11.	<u>                  </u>	<u>                  </u>	+ <u>              </u> - <u>              </u>
12.	<u>                  </u>	<u>                  </u>	+ <u>              </u> - <u>              </u>

I/O CABLE GUIDE

CABLE           C8          

PAIR	FUNCTION CH/BIT	TERMINATING CONN	CONN PIN
1.	D1	TOOTER	+ A - B
2.	D2	TOOTER	+ C - D
3.	D3	TOOTER	+ E - F
4.	D5	TOOTER	+ K - L
5.	D6	TOOTER	+ M - N
6.	TERM		+ -
7.	TERM		+ -
8.	TERM		+ -
9.	+ 24VDC	TOOTER	+ W - X
10.			+ -
11.			+ -
12.			+ -

I/O CABLE GUIDE

CABLE           C9          

PAIR	FUNCTION CH/BIT	TERMINATING CONN	CONN PIN
1.	D1	BULLWINKLE	+ A - B
2.	D2	BULLWINKLE	+ C - D
3.	D3	BULLWINKLE	+ E - F
4.	D4	BULLWINKLE	+ H - J
5.	D5	BULLWINKLE	+ K - L
6.	D6	BULLWINKLE	+ M - N
7.	D8	BULLWINKLE	+ S - T
8.	D9	BULLWINKLE	+ U - V
9.	TERM		+ -
10.			+ -
11.			+ -
12.			+ -

I/O CABLE GUIDE

CABLE C10

PAIR	FUNCTION CH/BIT	TERMINATING CONN	CONN PIN
1.	D10	BULLWINKLE	+ W - X
2.	D11	BULLWINKLE	+ Y - Z
3.	D12	BULLWINKLE	+ a - b
4.	D13	BULLWINKLE	+ c - d
5.	D14	BULLWINKLE	+ e - f
6.	D15	BULLWINKLE	+ h - j
7.	D16	BULLWINKLE	+ k - l
8.	D17	BULLWINKLE	+ m - n
9.	+ 24VDC	BULLWINKLE	+ AA - BB
10.			+ -
11.			+ -
12.			+ -

I/O CABLE GUIDE

CABLE C11

PAIR	FUNCTION CH/BIT	TERMINATING CONN	CONN PIN
1.	D18	BULLWINKLE	+ p - r
2.	D1	UNDERDOG	+ A - B
3.	D2	UNDERDOG	+ C - D
4.	D3	UNDERDOG	+ E - F
5.	D4	UNDERDOG	+ H - J
6.	D5	UNDERDOG	+ K - L
7.	D6	UNDERDOG	+ M - N
8.	D8	UNDERDOG	+ S - T
9.	+ 24VDC	UNDERDOG	+ SS - TT
10.			+ -
11.			+ -
12.			+ -

I/O CABLE GUIDE

CABLE C12

PAIR	FUNCTION CH/BIT	TERMINATING CONN	CONN PIN
1.	D9	UNDERDOG	+ U - V
2.	D10	UNDERDOG	+ W - X
3.	D11	UNDERDOG	+ Y - Z
4.	D12	UNDERDOG	+ AA - BB
5.	D1	BORIS & NATASHA	+ A - B
6.	D2	BORIS & NATASHA	+ C - D
7.	D4	BORIS & NATASHA	+ H - J
8.	D5	BORIS & NATASHA	+ K - L
9.	TERM		+ -
10.			+ -
11.			+ -
12.			+ -

I/O CABLE GUIDE

CABLE     C13    

PAIR	FUNCTION CH/BIT	TERMINATING CONN	CONN PIN
1.	<u>    D1    </u>	<u>    WATER SHOW    </u>	<u>  +  A    </u> <u>  -  B    </u>
2.	<u>    D2    </u>	<u>    WATER SHOW    </u>	<u>  +  C    </u> <u>  -  D    </u>
3.	<u>    D3    </u>	<u>    WATER SHOW    </u>	<u>  +  E    </u> <u>  -  F    </u>
4.	<u>    D4    </u>	<u>    WATER SHOW    </u>	<u>  +  H    </u> <u>  -  J    </u>
5.	<u>    D5    </u>	<u>    WATER SHOW    </u>	<u>  +  K    </u> <u>  -  L    </u>
6.	<u>    D6    </u>	<u>    WATER SHOW    </u>	<u>  +  M    </u> <u>  -  N    </u>
7.	<u>    D7    </u>	<u>    WATER SHOW    </u>	<u>  +  P    </u> <u>  -  R    </u>
8.	<u>    D8    </u>	<u>    WATER SHOW    </u>	<u>  +  S    </u> <u>  -  T    </u>
9.	<u>    TERM    </u>	<u>                    </u>	<u>  +          </u> <u>  -          </u>
10.	<u>            </u>	<u>                    </u>	<u>  +          </u> <u>  -          </u>
11.	<u>            </u>	<u>                    </u>	<u>  +          </u> <u>  -          </u>
12.	<u>            </u>	<u>                    </u>	<u>  +          </u> <u>  -          </u>

I/O CABLE GUIDE

CABLE     C14    

PAIR	FUNCTION CH/BIT	TERMINATING CONN	CONN PIN
1.	D9	WATER SHOW	+ U - V
2.	D10	WATER SHOW	+ W - X
3.	D11	WATER SHOW	+ Y - Z
4.	D12	WATER SHOW	+ a - b
5.	D13	WATER SHOW	+ c - d
6.	D14	WATER SHOW	+ e - f
7.	D15	WATER SHOW	+ h - i
8.	D16	WATER SHOW	+ k - l
9.	TERM		+ -
10.			+ -
11.			+ -
12.			+ -



I/O CABLE GUIDE

CABLE C15

PAIR	FUNCTION CH/BIT	TERMINATING CONN	CONN PIN
1.	D17	WATER SHOW	+ m - n
2.	D18	WATER SHOW	+ p - r
3.	D19	WATER SHOW	+ s - t
4.	D# 20	DIMMER	+ EE - FF
5.	TERM		+ -
6.	TERM		+ -
7.	TERM		+ -
8.	TERM		+ -
9.	TERM		+ -
10.			+ -
11.			+ -
12.			+ -

I/O CABLE GUIDE

CABLE SNIDELY

PAIR	FUNCTION CH/BIT	TERMINATING CONN	CONN PIN
1. 1	D1	_____	+ A - B
2. 2	D2	_____	+ C - D
3. 3	D3	_____	+ E - F
4. 4	D4	_____	+ H - J
5. 5	D5	_____	+ K - L
6. 6	D6	_____	+ M - N
7. 7	D7	_____	+ P - R
8. 8	D8	_____	+ S - T
9. TERM		_____	+ -
10.		_____	+ -
11.		_____	+ -
12.		_____	+ -

ELCO CONN. PIN PAIRS

20 + 38 PIN

Connector AUDIO (COMPUTER CHASSIS)

<u>PAIR</u>	<u>FUNC.</u>	<u>PAIR</u>	<u>FUNC.</u>
1. A B	D1	12. AA BE	
2. C D	D2	13. CC DD	
3. E F	D3	14. EE FF	
4. H J	D4	15. HH JJ	
5. K L	D5	16. KK LL	
6. M N	D6	17. MM NN	
7. P R	D7	18. PP RR	
8. S T	D8	19. SS TT	
9. U V			
10. W X			
11. Y Z			

ELCO CONN. PIN PAIRS

20 + 38 PIN

Connector CURTAINS

<u>PAIR</u>	<u>FUNC.</u>	<u>PAIR</u>	<u>FUNC.</u>
1. A B	D1	12. AA BE	
2. C D	D2	13. CC DD	
3. E F	D3	14. EE FF	
4. H J	D4	15. HH JJ	
5. K L	D5	16. KK LL	
6. M N	D6	17. MM NN	
7. P R		18. PP RR	
8. S T		19. SS TT	
9. U V			
10. W X			
11. Y Z			

ELCO CONN. PIN PAIRS

20 + 38 PIN

Connector DIMMERS

PAIR	FUNC.			
1. A B	R/B	D1	Dudley	41 <small>DREAM CROSS</small>
2. C D	w/B	A1	Left Hill	42
3. E F	G/B	D2	Rocky	33
4. H J	Bl/B	D3	Bullwinde	32
5. K L	BV/B	A2	Center Hill	45
6. M N	Y/B	D4	Indendog	43
7. P R	O/B	A3	Right Hill	44
8. S T	R/G	D5	Paris/Nat.	34
9. U V	R/W	D6	Hop/lotte	46
10. W X	R/B	A4	Grass Hill	36
11. Y Z	R/Y	A5	Yellow	37

PAIR	FUNC.			
12. AA BE	R/BV	A6	Blue	38 <small>DREAM CROSS</small>
13. CC DD	R/O	A7	Red	39
14. EE FF	G/BL	D20 D21	Grube	
15. HH JJ	G/W	A8 A8	House	40
16. KK LL				
17. MM NN				
18. PP RR				
19. SS TT				

ELCO CONN. PIN PAIRS

20 + 38 PIN

Connector DUDLEY

<u>PAIR</u>	<u>FUNC.</u>	<u>PAIR</u>	<u>FUNC.</u>
1. A B	D1 Red	12. AA BE	A1 R/Brown
2. C D	D2 W	13. CC DD	D12 R/O
3. E F	D3 G	14. EE FF	
4. H J	D4 Blue	15. HH JJ	
5. K L	D5 Brown	16. KK LL	
6. M N	D6 Y	17. MM NN	
7. P R	D7 O	18. PP RR	
8. S T	D8 R/G	19. SS TT	+ 24VDC G/Blue GND
9. U V	D9 R/W		
10. W X	D10 R/B		
11. Y Z	D11 R/Y		

ELCO CONN. PIN PAIRS

20 + 38 PIN

Connector HOPPITY

<u>PAIR</u>	<u>FUNC.</u>
1. A B	D1 <u>R/B</u>
2. C D	D2 <u>W/B</u>
3. E F	D3 <u>G/B</u>
4. H J	D4 <u>B/B</u>
5. K L	A1 <u>Bwn/B</u>
6. M N	
7. P R	
8. S T	
9. U V	
10. W X	+ 24VDC GND <u>Y / BLK</u>
11. Y Z	

<u>PAIR</u>	<u>FUNC.</u>
12. AA BE	
13. CC DD	
14. EE FF	
15. HH JJ	
16. KK LL	
17. MM NN	
18. PP RR	
19. SS TT	

ELCO CONN. PIN PAIRS

20 + 38 PIN

Connector ROCKY

<u>PAIR</u>	<u>FUNC.</u>	<u>PAIR</u>	<u>FUNC.</u>
1. A B	D1 R	12. AA BE	
2. C D	D2 W	13. CC DD	
3. E F	D3 G	14. EE FF	
4. H J	D4 R	15. HH JJ	
5. K L	D5 BN	16. KK LL	
6. M N	D6 Y	17. MM NN	
7. P R	D7 D	18. PP RR	
8. S T	D8 R/G	19. SS TT	+ 24VDC R/Y GND
9. U V	D9 R/W		
10. W X	A1 R/B		
11. Y Z			



ELCO CONN. PIN PAIRS  
20 + 38 PIN

Connector TOOTER

<u>PAIR</u>	<u>FUNC.</u>
1. A B	D1
2. C D	D2
3. E F	D3
4. H J	D4
5. K L	D5
6. M N	D6
7. P R	A1
8. S T	
9. U V	
10. W X	+ 24VDC GND
11. Y Z	

<u>PAIR</u>	<u>FUNC.</u>
12. AA BE	
13. CC DD	
14. EE FF	
15. HH JJ	
16. KK LL	
17. MM NN	
18. PP RR	
19. SS TT	

ELCO CONN. PIN PAIRS

56 PIN

Connector BULLWINKLE

<u>PAIR</u>	<u>FUNC.</u>	<u>PAIR</u>	<u>FUNC.</u>
1. A B	D1 R/B	12. a b	D12 R/Brown
2. C D	D2 W	13. c d	D13 R/O
3. E F	D3 G	14. e f	D14 G/Blue
4. H J	D4 Blue	15. h j	D15 G/W
5. K L	D5 BK/W	16. k l	D16 G/BK
6. M N	D6 Y	17. m n	D17 G/O
7. P R	D7 O	18. p r	D18 G/Y
8. S T	D8 R/G	19. s t	A1 W/Blue
9. U V	D9 R/W/A	20. u v	W/BK
10. W X	D10 R/B	21. w x	W/O
11. Y Z	D11 R/Y	22. y z	W/Y
		23. AA BB	+ 24VDC GND B/Y

ELCO CONN. PIN PAIRS  
20 + 38 PIN

Connector UNDERDOG

<u>PAIR</u>	<u>FUNC.</u>	<u>PAIR</u>	<u>FUNC.</u>
1. A B	D1 R/B	12. AA BE	D12 R/BEN
2. C D	D2 W/B	13. CC DD	A1 R/O
3. E F	D3 G/B	14. EE FF	
4. H J	D4 Blue/B	15. HH JJ	
5. K L	D5 brown/B	16. KK LL	
6. M N	D6 Y/B	17. MM NN	
7. P R	D7 O/B	18. PP RR	
8. S T	D8 R/G	19. SS TT	± 24VDC G/Blue GND
9. U V	D9 R/W		
10. W X	D10 R/Blue		
11. Y Z	D11 R/Y		

ELCO CONN. PIN PAIRS

20 + 38 PIN

Connector BORIS & NATASHA

<u>PAIR</u>	<u>FUNC.</u>
1. A B	D1 <i>e/b</i>
2. C D	D2 <i>w/b</i>
3. E F	D3 <i>G</i>
4. H J	D4 <i>blue</i>
5. K L	D5 <i>pen</i>
6. M N	D6 <i>y</i>
7. P R	
8. S T	
9. U V	
10. W X	
11. Y Z	

<u>PAIR</u>	<u>FUNC.</u>
12. AA BE	
13. CC DD	
14. EE FF	
15. HH JJ	
16. KK LL	
17. MM NN	
18. PP RR	
19. SS TT	

ELCO CONN. PIN PAIRS

56 PIN

Connector WATER SHOW

<u>PAIR</u>	<u>FUNC.</u>
1. A B	D1 R/B
2. C D	D2 W/B
3. E F	D3 G/B
4. H J	D4 Blu/B
5. K L	D5 BRN/B
6. M N	D6 U/B
7. P R	D7 O/B
8. S T	D8 R/G
9. U V	D9 R/W
10. W X	D10 R/Blu
11. Y Z	D11 R/Y

<u>PAIR</u>	<u>FUNC.</u>
12. a b	D12 R/BRN
13. c d	D13 R/O
14. e f	D14 G/Blu
15. h j	D15 G/W
16. k l	D16 G/BRN
17. m n	D17 G/O
18. p r	D18 G/Y
19. s t	D19 W/Blu
20. u v	A1 W/BRN
21. w x	DIMMER D20 G/B
22. y z	W/Y
23. AA BB	Blu/Y

ELCO CONN. PIN PAIRS

Connector SNIDELY

<u>PAIR</u>	<u>FUNC.</u>
1. A B	D1 <u>RED/BLACK</u>
2. C D	D2 <u>WH/BLACK</u>
3. E F	D3 <u>GRN/BLK</u>
4. H J	D4 <u>BLUE/BLK</u>
5. K L	D5 <u>BRN/BLK</u>
6. M N	D6 <u>YEL/BLK</u>
7. P R	D7 <u>ORG/BLK</u>
8. S T	D8 <u>RED/GRN</u>
9. U V	
10. W X	
11. Y Z	

<u>PAIR</u>	<u>FUNC.</u>
12. AA BE	
13. CC DD	
14. EE FF	
15. HH JJ	
16. KK LL	
17. MM NN	
18. PP RR	
19. SS TT	

## TECHNICAL GLOSSARY

- ACTUATOR - A device which is used to move an animated structure (example - headturn, arm up/down, body forward and back).
- AMPLIFIER - Professional audio power amplifier, dual-mono configuration. Amplifiers and speakers serve as dedicated pairs in the animation system.
- ANALOG FUNCTION - This refers to any proportional robotic movement, as opposed to a digital function.
- ANALOG I/O PANEL - Control system output module. Each panel has 16 individual analog (0-10 VDC) outputs.
- BEARING - A part that reduces the friction of motion between fixed and moving machined parts.
- BEARING HOUSING - A mountable holder for the bearing.
- BELLCRANK - Mechanism for achieving indirect drive.
- CLEVIS - The part that connects the rod end to a moveable mechanism.
- CONTROL MODULE - Dedicated electronic module which performs various show control functions including demodulation, show timing, automatic start, tape machine select, remote control, and sound switching.
- CPU - Central processing unit. This device receives data through the demodulator, processes the data and outputs it to the I/O panels.
- DEMODULATOR - This device processes tonal information from the tape machine and converts it to binary code.

DIGITAL FUNCTION - This refers to any two-position robotic function. Most of the movements in the show are of this type.

DIGITAL I/O PANEL - Control system output module. Each panel has 16 individual 24 VDC digital outputs.

DIGITAL VALVE - This is a 24 VDC activated solenoid air control valve used to initiated digital functions.

DIMMER - A.C. voltage power control device used to control the animated show and house lights. Two light-lab 8 channel dimmers are used in the system. Each channel has a recommended limit of 1000 watts.

FEEDBACK POT - Precision potentiometer used in conjunction with an actuator to sense relative position of an analog function.

FIGURE - Generic term for animated robotic characters.

FUNCTION - Generic term for any robotic movement.

FUSE - Fuses provide short circuit and over-load protection at all critical junction. Each I/O panel primary has a 2 amp slo-blow buss fuse. Each I/O panel secondary has a 6 amp slo-blow buss fuse. Each individual I/O function is fused with a 1 amp micro fuse.

LINEAR ACTUATOR - A sealed air driven cylinder with a shaft and piston enclosed for straight forward movement.

LINEAR MOVEMENT - A movement relating to a straight line.



NYLATRON - Carbon nylon composition material used in areas to reduce friction, such as slides.

OILITE BUSHINGS - Self lubricating oil impregnated bushings, non roller bearing.

PEEN - A technique for securing a bearing into a housing. The flat edge of the housing is flared by using a punch at evenly spaced points.

RACE - The outer edge of the face of a bearing.

ROD END - An encased ball bearing with either a threaded female or male rod.

ROTARY ACTUATOR - A sealed, air driven cylinder with a vaned shaft used for circular movement.

ROTARY MOVEMENT - A movement relating to a circular motion. A rotating movement can also be achieved by using a linear actuator and a bellcrank.

SERVO CARD - Each analog function has a servo card to serve as an interface and signal conditioner between the analog I/O output and the pneumatic servo valve. This plug-in electronic module is normally located near the base of figure that it is associated with.

SERVO VALVE - Electrically operated proportional pneumatic control device, used in conjunction with a servo card and an analog input signal to achieve an analog function. The feedback pot closes the servo loop back to the servo card.

SYSTEM STATUS - This series of eight LED's serves as an indicator of the CPU's internal status relative to the software as it's received from the magnetic tape.

TAPE DECK - The control system contains (2) special Otari 1/4" 4-track reel to reel playback tape machines. One machine is used for normal show operation, and other is a remote start machine for special shows (Birthdays, etc.). Three of the four tracks are for audio. The fourth contains computer data.

TIMER - The automatic show start is controlled by a LM 556 based timer. The timer senses the end of the preceding show, then starts the next show when a predetermined amount of time has expired. The timer has been adjusted at the factory and should not be readjusted.

# INDEX

TITLE	DWG. NO.	PAGE
Audio Function Bit Map	131712 09 4013	6-15
Boris' Eye Assembly	131704 03 2008	4-35
Boris & Natasha's Functions	131712 10 5007	6-32
Boris & Natasha's Function Bit Map	131712 09 4009	6-31
Bullwinkle's Eye Assembly	131704 03 2002	4-32
Bullwinkle's Functions	131712 10 5001	6-28
Bullwinkle's Function Bit Map	131712 09 4003	6-27
Bullwinkle's Lighting	131712 05 7001	2-13
Control Module	131712 09 4251	7-2
Curtain Diagram	131712 05 5253	6-16
Dudley Do-Right's Eye Assembly	131704 03 2005	4-26
Dudley Do-Right's Functions	131712 10 5004	6-20
Dudley Do-Right's Function Bit Map	131712 09 4006	6-19
General Engineering 8 Channel Dimmer	142 952	7-14
General Figure Animation System	131712 10 5009	2-3
Hoppity's Eye Assembly	131704 03 2009	4-28
Hoppity Hooper's Functions	131712 10 5008	6-22
Hoppity Hooper's Function Bit Map	171712 09 4010	6-21
Intel Schematics	142 952	7-14
Lighting System's Function Bit Map	131712 09 4011	6-18
Natasha's Eye Assembly	131704 03 2010	4-34
Otari Head Adjustment	131712 09 4503	7-10
Otari PCB		7-6
Otari Schematics	PB15Z0A	7-11
Rocky's Eye Assembly	131704 03 2006	4-29
Rocky's Functions	131712 10 5005	6-24
Rocky's Function Bit Map	131712 09 4007	6-23
Schematic Diagram Analog Board	131712 09 4252	7-3
Schematic Diagram Digital Board	131712 09 4253	7-4
Servo Card	131712 09 4501	4-15
Show Control System	131712 09 4002	2-5
Show Curtain's Function Bit Map	131712 09 4014	6-17

Single Analog Repair Procedure	131712	13	7251	4-9
Single Digital Function Repair Procedure	131712	13	7252	4-5
Snidely's Control Module	131712	09	4502	6-34
Snidely's Control System	131712	09	4001	2-15
Snidely's Eye Assembly	131704	03	2004	4-36
Snidely's Functions	131712	10	5003	6-36
Snidley Stage	131712	05	5252	1-3
Stage Layout	131712	05	5251	1-2
Standard Eye Assembly	131904	03	2001	4-22
Standard Eyebrow Assembly	131904	03	2011	4-24
Tooter's Eye Assembly	131704	03	2007	4-31
Tooter Turtle's Functions	131712	10	5006	6-26
Tooter Turtle's Function Bit Map	131712	09	4008	6-25
Underdog's Eye Assembly	131704	03	2003	4-33
Underdog's Functions	131712	10	5002	6-30
Underdog's Function Bit Map	131712	09	4004	6-29
Water Show's Function Bit Map	131712	09	4012	6-33

AVG PRODUCTIONS  
VALENCIA, CALIFORNIA

SERVO CARD FIELD SET UP  
20 TURNS

1. Initial Pot Settings

Offset	Fully CCW	Min
Stroke	Fully CW	Max
F.B. Hi	Fully CW	Max
F.B. Lo	Fully CCW	Min
Local	Any Position	
Gain	<del>Any Position</del>	
Velocity	<del>Any Position</del>	

FULLY CW THEN CCW 4-5 TURNS  
" CCW 3-4 TURNS

2. Put SI in the Local Position.

3. Adjust the Gain and Velocity <sup>POTS</sup> for the desired response <sup>check</sup> by varying the local pot.

4. Set the local pot to full CW then turn the F.B HI CCW until the piston is just at the full extended position.

5. Set the local Pot to full CCW then turn the F.B. Lo CW until the piston is just at the full retract position.

6. Set the local pot to full CW then turn the F.B. HI CCW until the piston is just at the full extend position.

7. Set the local Pot to full CCW then turn the offset CW until the desired retract position is reached.

8. Set the local Pot to full CW then turn the stroke CCW until the desired extend position is reached.

NOTE: If the gain is changed Steps 1 through 8 must be repeated. The stroke or velocity may be changed to select a new extend position and/or rate without affecting any other POT adjustments. If the offset is changed, the stroke must be readjusted to maintain the previous extend position.

# Cylinder cross reference

	Bullwinkle	Rocky	Boris / Nat	Underdog	Tooter	Hoopity	Dudley	Snidely
1/2" bore x 1/4" stroke	D-1,D-14			D-1,11,12			D-1	D-1
1/2" bore x 1/2" stroke	D-3,4 D-5,6	D-2,3	D-1,2 D-4,5	D-3,4 D-5,6	D-2,3	D-1,2		D-3,4
1/2" bore x 1/2" stroke		D-8			D-1			
1/2" bore x 3/4" stroke	D-2			D-2			D-3,4	D-2
1/2" bore x 1" stroke								
3/4" bore x 1/2" stroke		D-4						
3/4" bore x 1" stroke					D-4	D-3,4	D-7,D-9	D-5
1" bore x 1/4" stroke		D-1						
1" bore x 1/2" stroke			D-3,D-6				D-2,D-5	
1" bore x 1" stroke	D-15,D-18						D-8	
1" bore x 1" stroke		D-5,6						D-6,7
1" bore x 2" stroke		D-9						
1" bore x 3" stroke		D-7						
1" bore x 6" stroke	D-12,13							
1 1/2" bore x 1/2" stroke								
1 1/2" bore x 1" stroke	D-7			D-7				D-8
1 1/2" bore x 1" stroke							D-10,11	
2" bore x 1/2" stroke								
2" bore x 1" stroke	D-8,D-16			D-10			D-6	
2" bore x 1" stroke	D-10,11							
2 1/2" bore x 1" stroke								
2 1/2" bore x 2" stroke	D-17			D-8				
1" bore X 30°					D-5,D-6			
1 1/2" bore X 90°					A-1			
1 1/2" bore X 30°						A-1		
2 " bore x 45°		A-1		A-1				
2 " bore x 60°							A-1	
2 1/2 " bore x 90°	A-1							



I/O CABLE GUIDE

CABLE CO

PAIR	FUNCTION CH/BIT	TERMINATING CONN	CONN PIN
1.	0/0	AUDIO	+ A - B
2.	0/1	CURTAIN	+ A - B
3.		N/C	+ -
4.		N/C	+ -
5.	0/4 DA	ROCKY	+ H - J
6.	0/5 D7	BULLWINKLE	+ P - R
7.	0/6 D3	BORIS/NAT.	+ E - F
8.	0/7 D6	BORIS/NAT	+ M - N
9.	TERM.		+ -
10.			+ -
11.			+ -
12.			+ -



I/O CABLE GUIDE

CABLE C1

PAIR	FUNCTION CH/BIT	TERMINATING CONN	CONN PIN
1.	D1	ROCKY	+ A - B
2.	D2	ROCKY	+ C - D
3.	D3	ROCKY	+ E - F
4.	D5	ROCKY	+ K - L
5.	D6	ROCKY	+ M - N
6.	D7	ROCKY	+ P - R
7.	D8	ROCKY	+ S - T
8.	D9	ROCKY	+ U - V
9.	TERM.		+ -
10.			+ -
11.			+ -
12.			+ -

I/O CABLE GUIDE

CABLE C2

PAIR	FUNCTION CH/BIT	TERMINATING CONN	CONN PIN
1.	D1	BULL.	+ A - B
2.	D2	BULL.	+ C - D
3.	D3	BULL.	+ E - F
4.	D4	BULL.	+ H - J
5.	D5	BULL.	+ K - L
6.	D6	BULL.	+ M - N
7.	D11	BULL.	+ Y - Z
8.	D12	BULL.	+ a - b
9.	TERM.		+ - +
10.			+ - +
11.			+ - +
12.			+ - +

I/O CABLE GUIDE

CABLE C3

PAIR	FUNCTION CH/BIT	TERMINATING CONN	CONN PIN
1.	D8	BULL.	+ S - T
2.	D9	BULL.	+ U - V
3.	D10	BULL.	+ W - X
4.	D13	BULL.	+ c - d
5.	D14	BULL.	+ e - f
6.	D15	BULL.	+ h - j
7.	D16	BULL.	+ k - l
8.	D17	BULL.	+ m - n
9.	TERM.		+ -
10.			+ -
11.			+ -
12.			+ -

I/O CABLE GUIDE

CABLE C13

PAIR	FUNCTION CH/BIT	TERMINATING CONN	CONN PIN
1.	<u>D1</u>	<u>WATER SNOW</u>	+ <u>A</u> - <u>B</u>
2.	<u>D2</u>	<u>WATER SNOW</u>	+ <u>C</u> - <u>D</u>
3.	<u>D3</u>	<u>WATER SNOW</u>	+ <u>E</u> - <u>F</u>
4.	<u>D4</u>	<u>WATER SNOW</u>	+ <u>H</u> - <u>J</u>
5.	<u>D5</u>	<u>WATER SNOW</u>	+ <u>K</u> - <u>L</u>
6.	<u>D6</u>	<u>WATER SNOW</u>	+ <u>M</u> - <u>N</u>
7.	<u>D7</u>	<u>WATER SNOW</u>	+ <u>P</u> - <u>R</u>
8.	<u>D8</u>	<u>WATER SNOW</u>	+ <u>S</u> - <u>T</u>
9.	<u>TERM.</u>		+ -
10.			+ -
11.			+ -
12.			+ -

I/O CABLE GUIDE

CABLE C14

PAIR	FUNCTION CH/BIT	TERMINATING CONN	CONN PIN
1.	<u>D9</u>	<u>WATER SLOW</u>	+ <u>U</u> - <u>V</u>
2.	<u>D10</u>	<u>WATER SLOW</u>	+ <u>W</u> - <u>X</u>
3.	<u>D11</u>	<u>WATER SLOW</u>	+ <u>Y</u> - <u>Z</u>
4.	<u>D12</u>	<u>WATER SLOW</u>	+ <u>a</u> - <u>b</u>
5.	<u>D13</u>	<u>WATER SLOW</u>	+ <u>c</u> - <u>d</u>
6.	<u>D14</u>	<u>WATER SLOW</u>	+ <u>e</u> - <u>f</u>
7.	<u>D15</u>	<u>WATER SLOW</u>	+ <u>h</u> - <u>j</u>
8.	<u>D16</u>	<u>WATER SLOW</u>	+ <u>k</u> - <u>l</u>
9.	<u>TERM.</u>	<u>-----</u>	+ <u>-----</u> - <u>-----</u>
10.	<u>-----</u>	<u>-----</u>	+ <u>-----</u> - <u>-----</u>
11.	<u>-----</u>	<u>-----</u>	+ <u>-----</u> - <u>-----</u>
12.	<u>-----</u>	<u>-----</u>	+ <u>-----</u> - <u>-----</u>

I/O CABLE GUIDE

CABLE C15

PAIR	FUNCTION CH/BIT	TERMINATING CONN	CONN PIN
1.	D17	WATER SHOW	+ <u>m</u> - <u>n</u>
2.	D18	WATER SHOW	+ <u>p</u> - <u>r</u>
3.	D19	WATER SHOW	+ <u>s</u> - <u>t</u>
4.	D7	DIMMER	+ <u>W</u> - <u>X</u>
5.	D1	BORIS/NAT	+ <u>A</u> - <u>B</u>
6.	D2	BORIS/NAT.	+ <u>C</u> - <u>D</u>
7.	D4	BORIS/NAT.	+ <u>H</u> - <u>J</u>
8.	D5	BORIS/NAT	+ <u>K</u> - <u>L</u>
9.			+ _____ - _____
10.			+ _____ - _____
11.			+ _____ - _____
12.			+ _____ - _____

I/O CABLE GUIDE

CABLE A1 (CH. 16-23)

PAIR	FUNCTION CH/BIT	TERMINATING CONN	CONN PIN
1.	16	ROCKY HEAD TURN	+ W - X
2.	17	BULL. HEAD TURN	+ S - t
3.	18	N/C	+ -
4.	19	N/C	+ -
5.	20	N/C	+ -
6.	21	N/C	+ -
7.	22	HOUSE LIGHTS LIGHTING	+ U - V
8.	23	BULL LIGHTING	+ A - B
9.	+ 24VDC	HEAD TURN + 24VDC ROCKY	+ SS - TT
10.			+ -
11.			+ -
12.			+ -

I/O CABLE GUIDE

CABLE A2 (CH. 24-31)

PAIR	FUNCTION CH/BIT	TERMINATING CONN LIGHTING	CONN PIN
1.	24	ROCKY	+ C - D
2.	25	B / NAT. LIGHTING	+ E - F
3.	26	CURTAIN WASH LIGHTING	+ H - J
4.	27	STAGE FILL LIGHTING	+ K - L
5.	28	H2O - YELLOW LIGHTING	+ M - N
6.	29	H2O BLUE LIGHTING	+ P - R
7.	30	H2O - RED LIGHTING.	+ S - T
8.	31	TRUNION MOTOR WATER SHOW	+ U - V
9.	+ 24VDC	HEADS TURN BULL. + 24VDC	+ AA - BB
10.			+ -
11.			+ -
12.			+ -



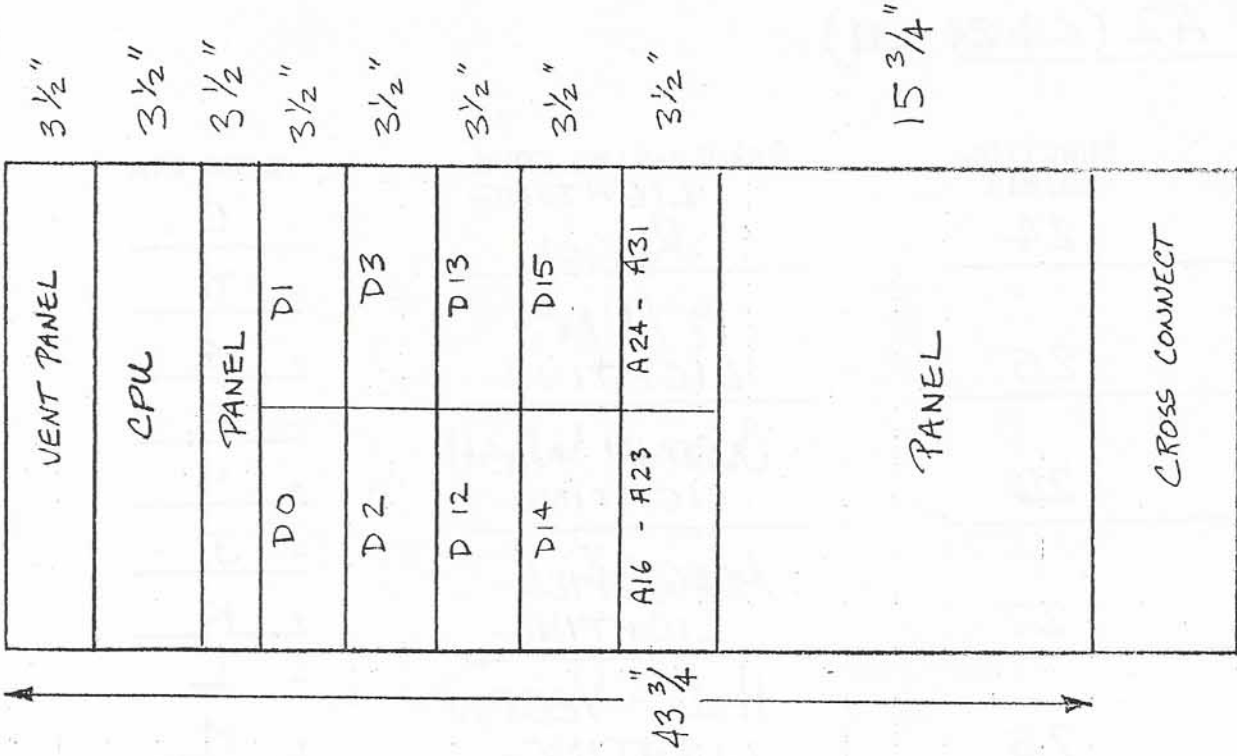
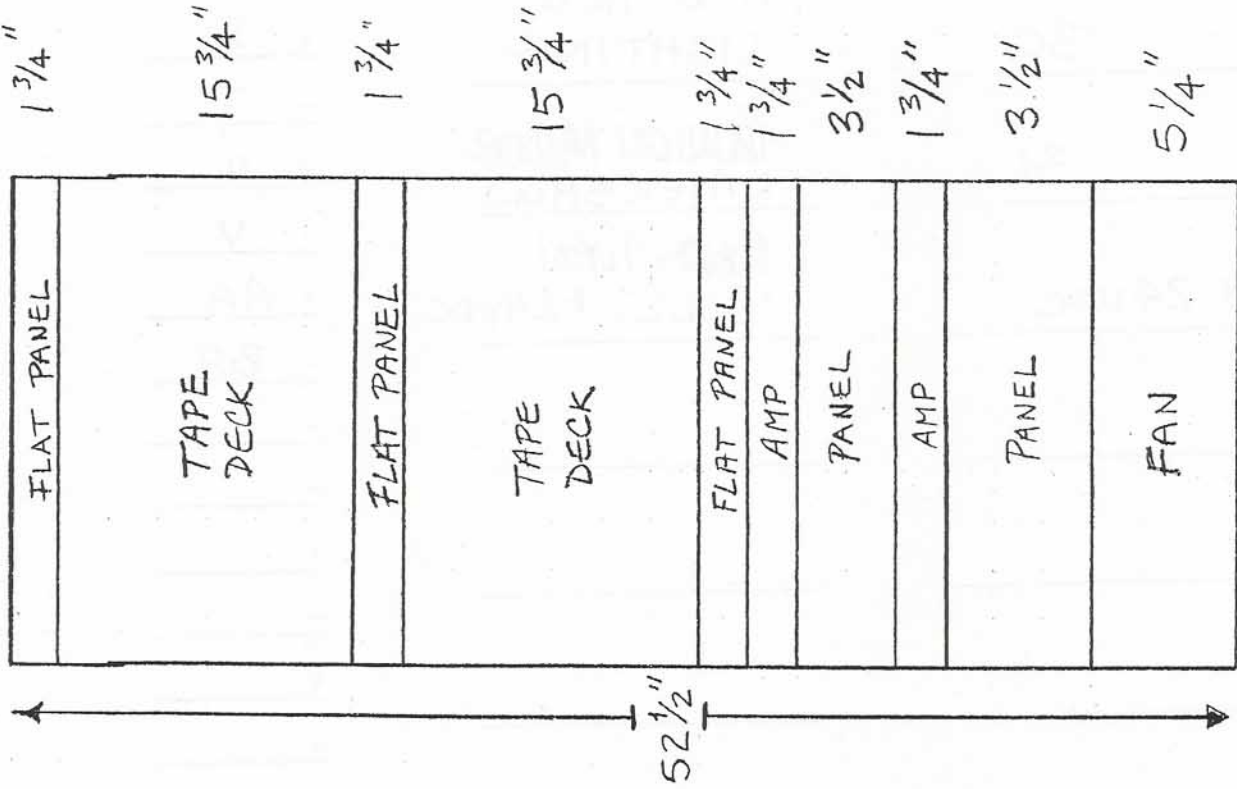

BULLWINKLE CONTROL  
VERSION "B" 4/10/85  
D.H.

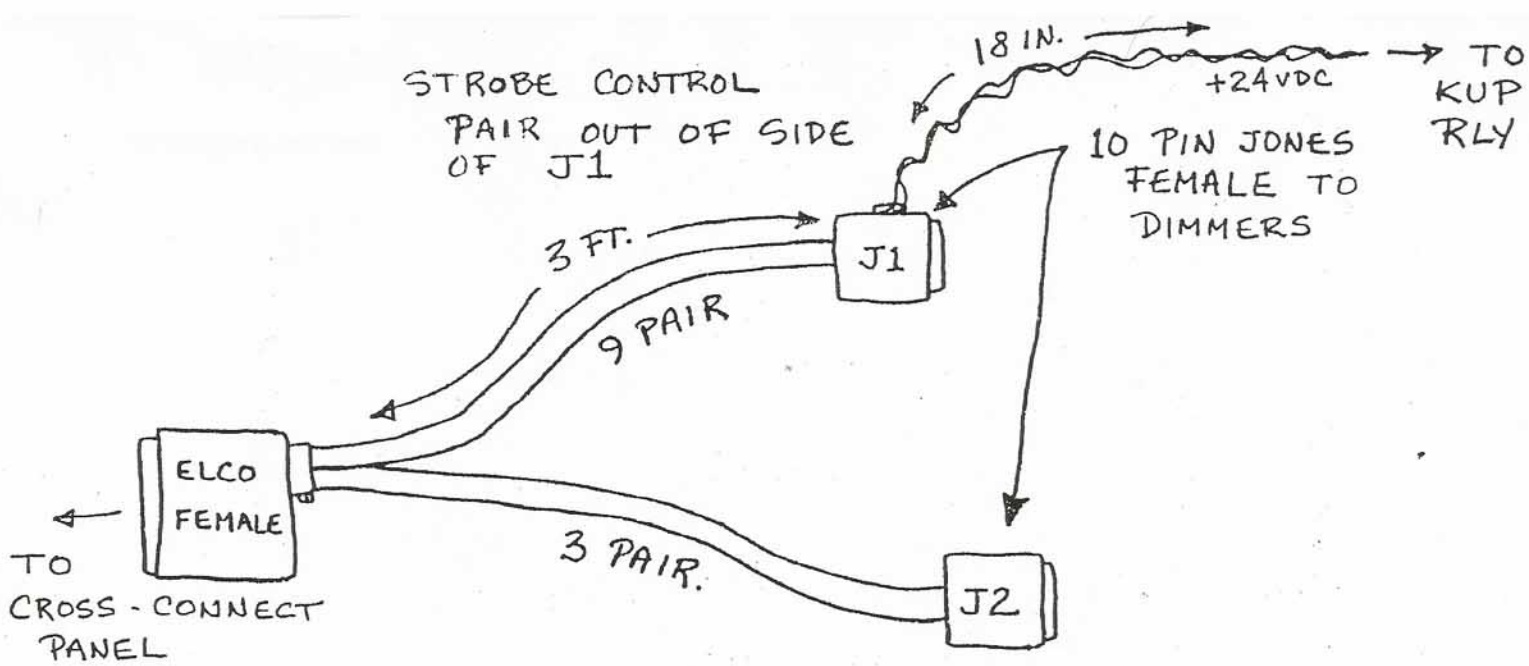

SOURCE (ELCO)	FUNCTION	DESTINATION (JONES)
A	CH. 1	J1 PIN 1
B		J1 PIN 8
C	CH. 2	J1 2
D		J1 8
E	CH. 3	J1 3
F		J1 8
G	CH. 4	J1 4
H		J1 8
I	CH. 5	J1 5
J		J1 8
K	CH. 6	J1 6
L		J1 8
M	CH. 7	J1 8
N		J2 1
O	CH. 8	J2 8
P		J2 2
Q		J2 8
R	CH. 9, 10, 11, 12	J2 3, 4, 5, 6
S		J2 8
T	STROBE	J1 SPECIAL
U		J1
V		
W		
X		

SCENEMASTER DIMMER USER GUIDE

DOVE SYSTEMS  
~~1199 4th St.~~  
~~Los Osos, CA 93402~~  
Copyright 1984 V1.1

9563 SUELDO CT. SUITE E  
SAN LUIS OBISPO. CA 93401  
805 541 8292  
FAX 541 8293

GRADY - TECHNICAL

EVAN  
DENISE

DM12  
12043  
12044

## SCENEMASTER DIMMER

### RECEIVING YOUR EQUIPMENT

As soon as you have received your equipment, open the boxes and examine the contents. If any damage is noted, contact the carrier immediately to file a claim for damages. You can be sure that when the equipment left the factory it was in good condition and properly packed.

If you find the equipment to be in accordance with your order and the packing slip, and also in good physical condition you may read on to the section covering SET-UP AND CONNECTION. If for some reason the equipment in the carton does not agree with your order or the packing slip, contact the factory immediately and we will be happy to help you.

### SET- UP AND CONNECTION

#### MECHANICAL INSTALLATION

Remove all packing material from the carton and from the unit. Make certain that all cooling fins and holes are free of obstruction on all sides of the unit.

For portable use, set the Scenemaster on a smooth, cool surface, preferably in an area which remains fairly cool. Maximum air temperature must not exceed 40 degrees Centigrade (105 degrees Fahrenheit). Make certain that the vent holes all have at least 6 inches of free air all around them. Up to 4 packs may be stacked vertically. Do not remove the feet when stacking. Do not block any vent holes. It is essential that this unit have adequate cooling for safe, reliable performance.

#### RACK MOUNTING

For larger systems, the Scenemaster can be rack mounted in a standard EIA 19-inch equipment rack. Rack ears may be easily attached to the heat sink. The Scenemaster occupies 3.5 inches of space in the rack. To insure proper operation, the rack enclosure must be ventilated. Air should be exhausted from the top of the cabinet at a minimum of 200 cubic feet per minute.

#### ELECTRICAL INSTALLATION

The Scenemaster consists of six dimming

channels. Each of these channels must be operated from 120 volts referenced to the neutral terminal. Frequency of operation is 50 or 60 Hertz. Minor adjustment may be required, at 50 Hz.

The six channels of the Scenemaster are divided into two banks of dimmers: Line 1 has 3 channels, line 2 has 3 channels. Because the Scenemaster controls the flow of electricity (Amps) to the lighting instruments, the dimmer must be supplied with an amount of power equal to the combined total wattage of the lamps it controls. To calculate the amps, use the formula  $\text{amps} = \text{watts} / \text{volts}$ . Lamp loads are rated in watts and designed to operate at 120 volts. For example, if six 1000-watt lighting units are connected to the dimmer, each line would require  $3000 / 120$ , or 25 amps (line 1 and 2). Note: in actual practice the lamp inefficiencies and line losses cause the actual power draw to be closer to 20 amps. Therefore, six 1000-watt lamps can be run at full brightness and operate on only two 20-amp power input circuits.

The Scenemaster IV has two motor base inlets and six U-ground receptacles. The motor base inlets can be connected to a regular wall outlet through heavy duty extension cord. Number 12 AWG with ground conductor is recommended. The wall outlets should be rated at 20 amps each and should be on separate 20-amp circuit breakers not sharing other heavy loads.

The Scenemaster XII and XX are higher power units that can have a variety of input and output connectors. These models have six channels, each protected by a 15-amp circuit breaker. The maximum input current is therefore 45 amps on each line. The input power connector can be a circular multipin connector, a terminal block, twistlock, or other connector. In any case, the conductors should be capable of 45 amps maximum. See Figure 1 for connector diagrams. The primary circuit protection and disconnect is to be provided by the user. Number 8 AWG is recommended for power feed.

Proper connection is very important. The Scenemaster may be connected in many ways. Regardless of the mode of connection, A NEUTRAL WIRE MUST BE CONNECTED, and all banks of dimmers must be connected.

It is also very important that the input voltages be checked with a meter to insure that they are correct. A mistake can place 208 to 240 volts across 120-volt lamps. The input fuse will protect the unit but may not save your lamps. A double check of voltages before applying power can guard against such disaster.

## GROUNDING

The term GROUNDING refers to a separate wire, with green insulation, which is connected from the equipment case to earth ground (often through a properly grounded conduit system). This is not the same as the neutral, or common, and must not be confused with it. The neutral is a separate, load-carrying circuit conductor.

When the Scenemaster is connected to its power source by a flexible rubber cable, the ground connection is made through a fourth wire in the cable. For maximum safety, and to comply with electrical codes, this connection must be made. Cables supplied by DOVE SYSTEMS are pre-wired for this connection and include the necessary green fourth wire. Be sure this is firmly bonded to a grounded connection box, a cold water pipe, or a known earth ground.

When the Scenemaster is connected to its power source by conduit, the ground connection can be made via the conduit itself. If flexible conduit is used, a separate bonding conductor will usually be required. Always check your local codes for hook-up before operating this equipment. It is recommended that power connections to the Scenemaster be made by a qualified electrician.

## LOAD CONNECTIONS

The Scenemaster will dim any load from 1 watt through 1500 watts. (2000 watts for SM XX) The load may be incandescent, inductive, or resistive. This includes conventional, incandescent, quartz incandescent, rain-lights, pin beams, and similiar lamp loads. The output connector can be U-ground, stage pin, or terminal block.

If your unit has receptacles installed, merely plug the load into the outlet which corresponds to the circuit you desire to use.

For terminal-block-only units, there is one lug for each output and one for each neutral. There must be a separate neutral returning from each load circuit. DO NOT COMMON NEUTRALS BETWEEN DIMMER AND LOAD. Lugs are numbered according to their circuits.

## CONTROL CONNECTIONS

The Scenemaster requires 6 control inputs, referenced to a signal common. This common is

30

isolated from the neutral, chassis, and electrical ground. Signal voltage is 0 to +10 volts pure DC. Maximum output is obtained at +10 volts.

When using DOVE SYSTEMS control consoles with the Scenemaster, merely insert the remote cable socket into the plug on the back panel. This connector is polarized, so be sure to line it up first. Do not force it.

Signal pins in the Cinch Jones connector are wired such that the pin number is the channel number. Pin #8 is common (Figure 2). Pin #9 supplies +15 volts and pin #10 supplies -15 volts to controllers that require external power.

## INDICATORS

The green LED indicators on the front panel (L1 and L2) indicate that line voltage is present. The red LED's indicate triac drive current on each channel. These track the input voltage and are brightest at 10 volts input. At zero volts input, the red LED's should be on, but dimly, indicating proper idle adjustment.

## ELECTRICAL SAFETY

### 1. KNOW YOUR EQUIPMENT

Read the owner's manual carefully. Learn its applications and limitations as well as the specific potential hazards associated with the product.

### 2. PROPER GROUNDING

The equipment is equipped with grounding means to help insure safety in the event of an insulation failure in the product or with other equipment in the chain. DO NOT ignore this connection or attempt to defeat it.

### 3. KEEP COVERS IN PLACE

Do not operate electrical equipment with the protective covers removed. De-energize feed lines before removing any covers or otherwise exposing high voltages.

### 4. KEEP OPERATING AREA CLEAN

Don't let objects or materials accumulate near the vents on dimmers. Also, dust build-up on cooling components can reduce the performance of the unit.

### 5. AVOID DANGEROUS ENVIRONMENT

Do not use electrical equipment in damp or wet locations, nor expose it to rain.

control operation. Check that the control cable is intact, and plugged in at both ends. The POWER ON light in the control console should light up.

FAILED ON dimmers will stay on regardless of the control setting. Unplug the control console from the Scenemaster. If the failure goes away, the cable or console is at fault. If the channel remains on, the Triac circuit has failed and must be repaired. Contact your dealer or the factory for this repair.

#### OBTAINING SERVICE

If, after performing these tests, you still cannot get proper operation, you may send your unit to the factory, freight prepaid, with a note describing the specific complaint and the results of the checks noted above. Send to:

Service Department  
Dove Systems  
1199 4th St.  
Los Osos, CA 93402

Those who wish to do their own repairs should buy a service manual which includes complete schematics and troubleshooting guide. Unauthorized repair on our products shall void the warranty and the buyer may be charged for subsequent factory repair, even though the product is defective. Call the factory Service Department for information about our service policy, ordering parts, or for help repairing a unit.

Phone DOVE SYSTEMS (805) 528-1683.



#### 6. DO NOT FORCE THE EQUIPMENT

Use it within the specified ratings. Don't overload channels or use frayed, worn cables or damaged instruments.

#### 7. MAINTAIN EQUIPMENT

Preventive maintenance will help your dimmers operate longer and more safely. Follow instructions for cleaning and checking for failures.

#### 8. DISCONNECT EQUIPMENT

Do not work on the dimmers while energized. Make connections to de-energize channels (no hot patching). Don't leave the dimmers energized overnight or during other unattended times.

#### 9. USE RECOMMENDED ACCESSORIES

Consult the owner's manual and the manufacturer's literature for recommended accessories. Follow the instructions that accompany them. The use of improper or home-built accessories may cause hazards.

#### 10. CHECK DAMAGED PARTS

Before further use of the dimmer, parts that are damaged or that have malfunctioned should be carefully checked or replaced to insure that it will operate properly and perform its intended function.

### TROUBLESHOOTING

The Scenemaster is designed to resist the hard treatment of touring use. It can even withstand overvoltages and short circuits. Often what appears to be a problem with the dimmer is something else. A review of the following may save you a long distance phone call, or the cost of shipping and/or repair. Even if something is still wrong, this process will help you explain the malfunction to a service technician.

There are some basic checks that you can do to help isolate a problem. The two forms of malfunction common to solid state dimmers are: FAILED OFF, in which the lights do not come on, and FAILED ON, in which the lights cannot be turned off. If your system has FAILED OFF, check that a lamp load is connected and that the lamp is not burned out. Verify that the primary power is live and that the dimmer is on (all LED's are glowing). If either green LED is off, check fuses on the main circuit board. If the dimmer is operating, check the channel fuses. Make sure the loads are plugged in and that all extension cords are continuous, and that they go to the loads you think they do. Check load circuits by plugging them into regular wall outlets. If the dimmer is getting power and the loads check out, you may not be getting proper

APPLICATION		REVISION			
NEXT ASSY	USED ON	LTR	DESCRIPTION	DATE	APPROVED
			FIGURE 2: 10-PIN CINCH JONES		

10-PIN CINCH JONES CONTROL CONNECTOR

<u>PIN</u>	<u>FUNCTION</u>
1.	Chn. 1
2.	2
3.	3
4.	4
5.	5
6.	6
7.	Spare
8.	Common
9.	+15 Volts
10.	-15 Volts

UNLESS OTHERWISE SPECIFIED DIMENSIONS ARE IN INCHES TOLERANCES ARE:  FRACTIONS DECIMALS ANGLES ± .XX ± ± .XXX ±	CONTRACT NO.		<p align="center">FIGURE 2: 10-PIN CINCH JONES CONNECTOR</p> <p align="center"><b>DOVE SYSTEMS</b> 1199 4th Street LOS OSOS, CALIFORNIA 93402 (805) 528-1683 541 8292</p>	
	APPROVALS	DATE		
	DRAWN			
	CHECKED			
MATERIAL		SIZE	CODE IDENT NO.	DRAWING NO.
		<b>A</b>		
DO NOT SCALE DRAWING		SCALE		SHEET OF

APPLICATION		REVISION			
NEXT ASSY	USED ON	LTR	DESCRIPTION	DATE	APPROVED

MOTOR BASE INLET

3  $\Phi$  Y  
120/208 V

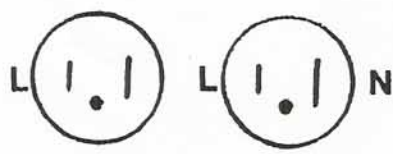

LOCKING INLET

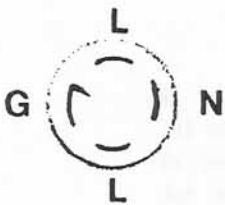

CIRCULAR CONNECTOR

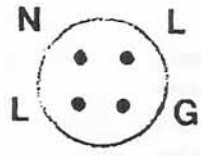

TERMINAL BLOCK

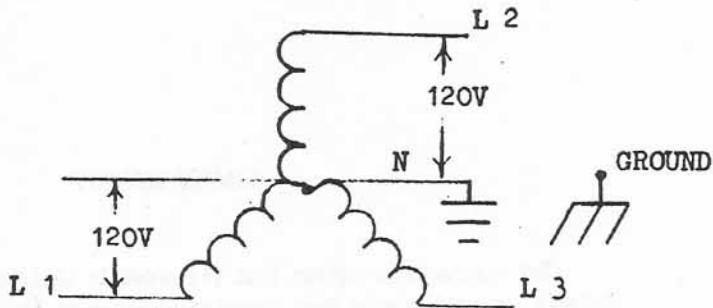

1  $\Phi$   
120/240 V

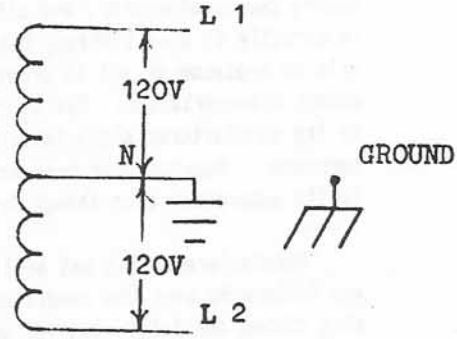

Note: For three phase power service the third phase leg (L3) is not connected.

UNLESS OTHERWISE SPECIFIED DIMENSIONS ARE IN INCHES TOLERANCES ARE: FRACTIONS DECIMALS ANGLES ± .XX ± ± .XXX ±	CONTRACT NO.		<p>FIGURE 1 SCENEMASTER IV INPUT POWER</p> <p><b>DOVE SYSTEMS</b> 1199 4th Street LOS OSOS, CALIFORNIA 93402 (805) 528-1683 541 8292</p>			
	APPROVALS					DATE
	DRAWN	GD				8-18-83
	CHECKED					
MATERIAL			SIZE	CODE IDENT NO.	DRAWING NO.	
FINISH			A			
DO NOT SCALE DRAWING			SCALE		SHEET OF	

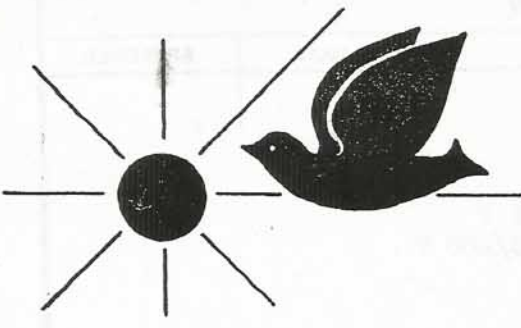

DOVE SYSTEMS  
LIGHTING CONTROL EQUIPMENT

1199 4th St.  
Los Osos, CA 93402  
(805) 528-1683 541-8292 - DAVE  
541-8293 - FAX

LIMITED WARRANTY

The manufacturer agrees that its products shall be free from defects in material or workmanship over a period of one year from date of shipment from the factory. Said warranty will not apply if equipment is used under conditions of service for which it is not specifically intended. The manufacturer is not responsible for damage to its apparatus through improper installation, physical damage, or poor operating practice.

If any device is found unsatisfactory under the warranty, the buyer should notify the manufacturer, and after receipt of shipping advice, buyer may return it directly to Dove Systems, Los Osos, CA, shipping prepaid. Such equipment will be replaced or put in proper operating condition, free of all charges except transportation. The correction of any defects by repair or replacement by the manufacturer shall constitute fulfillment of all obligations to the purchaser. Manufacturer does not assume responsibility for unauthorized repairs to its apparatus, even though defective.

Manufacturer shall not be liable for any consequential damage in case of any failure to meet the conditions of any warranty or shipping schedule, nor will claims for labor, loss of profits, repairs, or other expenses incidental to replacement be allowed.

No other representation, guarantees or warranties, expressed or implied, are made by the manufacturer in connection with the manufacture and sale of its equipment. This warranty is non-transferable and applies to the original buyer only.

# BULLWINKLE'S FAMILY FOOD 'N FUN MAINTENANCE & OPERATION MANUAL

Date of Origin: 1984

Archived: 6-2-21

Submission by Steven

Version 1.0

The documents contained herein are for educational use only.  
Please do not replicate, redistribute, or make any unauthorized  
printings. All intellectual property including characters,  
artwork, photography, and slogans are trademark and/or  
copyright their respective owners.

